

USB-2533

16-bit, 1 MS/s, High-Speed DAQ Board

User's Guide

Trademark and Copyright Information

Measurement Computing Corporation, InstaCal, Universal Library, and the Measurement Computing logo are either trademarks or registered trademarks of Measurement Computing Corporation. Refer to the Copyrights & Trademarks section on mccdaq.com/legal for more information about Measurement Computing trademarks. Other product and company names mentioned herein are trademarks or trade names of their respective companies.

© 2016 Measurement Computing Corporation. All rights reserved. No part of this publication may be reproduced, stored in a retrieval system, or transmitted, in any form by any means, electronic, mechanical, by photocopying, recording, or otherwise without the prior written permission of Measurement Computing Corporation.

Notice

Measurement Computing Corporation does not authorize any Measurement Computing Corporation product for use in life support systems and/or devices without prior written consent from Measurement Computing Corporation. Life support devices/systems are devices or systems that, a) are intended for surgical implantation into the body, or b) support or sustain life and whose failure to perform can be reasonably expected to result in injury. Measurement Computing Corporation products are not designed with the components required, and are not subject to the testing required to ensure a level of reliability suitable for the treatment and diagnosis of people.

Table of Contents

Preface	
About this User's Guide	5
What you will learn from this user's guide	5
Conventions in this user's guide	5
Where to find more information	5
Chapter 1	
Introducing the USB-2533	6
Overview: USB-2533 features	6
Chapter 2	
Installing the USB-2533	7
Unpacking the USB-2533	7
Installing the software	7
Installing the hardware	7
Configuring the hardware	8
Signal connections	9
68-pin SCSI connector (P5)	10
40-pin header connectors (J5, J6, J7, J8)	13
Four-channel TC terminal block (TB7)	16
Cabling	17
Field wiring and signal termination	17
Chapter 3	
Functional Details	18
Board components	18
Functional block diagram	20
Synchronous I/O – mixing analog, digital, and counter scanning	21
Analog input	21
Analog input scanning	21
Thermocouple input	23
Tips for making accurate temperature measurements	24
Digital I/O	24
Digital input scanning	24
Digital outputs and pattern generation	25
Triggering	25
Hardware analog triggering	25
Digital triggering	25
Software-based triggering	25
Stop trigger modes	26
Pre-triggering and post-triggering modes	26
Counter inputs	26
Mapped channels	27
Counter modes	27
Debounce modes	28
Encoder mode	31
Timer outputs	34
Example: Timer outputs	34
Using detection setpoints for output control	35
What are detection setpoints?	35
Setpoint configuration overview	35
Setpoint configuration	36
Using the setpoint status register	37

Examples of control outputs	38
Detection setpoint details	40
FIRSTPORTC or timer update latency	40
Mechanical drawing	42
Chapter 4	
Calibrating the USB-2533	43
Chapter 5	
Specifications	44
Analog input	44
Accuracy	44
Thermocouples	45
Digital input/output	45
Counters	46
Input sequencer	46
Trigger sources and modes	47
Frequency/pulse generators	47
Power consumption	47
External power	48
USB specifications	48
Environmental	48
Mechanical	48
Signal I/O connectors	48
68-pin SCSI connector (P5)	49
40-pin header connectors	51
TC connector pin out (TB7)	54

About this User's Guide

What you will learn from this user's guide

This user's guide describes the Measurement Computing USB-2533 data acquisition device and lists the specifications.

Conventions in this user's guide

For more information

Text presented in a box signifies additional information and helpful hints related to the subject matter you are reading.

Caution! Shaded caution statements present information to help you avoid injuring yourself and others, damaging your hardware, or losing your data.

bold text **Bold** text is used for the names of objects on a screen, such as buttons, text boxes, and check boxes.

italic text *Italic* text is used for the names of manuals and help topic titles, and to emphasize a word or phrase.

Where to find more information

For additional information relevant to the operation of your hardware, refer to the Documents subdirectory where you installed the MCC DAQ software (C:\Program Files\Measurement Computing\DAQ by default), or search for your device on our website at www.mccdaq.com.

Introducing the USB-2533

Overview: USB-2533 features

The USB-2533 board is a multifunction measurement and control board that is supported under popular Microsoft® Windows® operating systems.

The USB-2533 provides the following features:

- 32 differential or 64 single-ended analog inputs with 16-bit resolution.
 - Software-selectable analog input ranges: ± 10 V, ± 5 V, ± 2 V, ± 1 V, ± 0.5 V, ± 0.2 V, ± 0.1 V.
 - Up to four thermocouple (TC) inputs
- 24 high-speed digital I/O lines
 - Up to 4 MHz scanning on all digital input lines¹.
- Two timer outputs
- Four 32-bit counters
- Synchronous analog input, digital I/O, and counter/timer I/O operations

¹ Higher rates—up to 12 MHz—are possible depending on the platform and the amount of data being transferred.

Installing the USB-2533

Unpacking the USB-2533

As with any electronic device, you should take care while handling to avoid damage from static electricity. Before removing the USB-2533 from its packaging, ground yourself using a wrist strap or by simply touching the computer chassis or other grounded object to eliminate any stored static charge.

If any components are missing or damaged, notify Measurement Computing Corporation immediately by phone, fax, or e-mail:

- Phone: 508-946-5100 and follow the instructions for reaching Tech Support
- Fax: 508-946-9500 to the attention of Tech Support
- Email: techsupport@mccdaq.com

For international customers, contact your local distributor. Refer to the International Distributors section on our web site at www.mccdaq.com/International.

Installing the software

Refer to the MCC DAQ Quick Start and the USB-2533 product page on our website for information about the available software.

Install the software before you install your device
--

The driver needed to run the USB-2533 is installed with the software. Therefore, you need to install the software package you plan to use before you install the hardware.
--

Installing the hardware

To connect the USB-2533 to your system, turn your computer on, and connect the USB cable to a USB port on your computer or to an external USB hub that is connected to your computer. The USB cable provides power and communication to the USB-2533.

When you connect the USB-2533 to a computer for the first time, a **Found New Hardware** dialog opens when the operating system detects the device. When the dialog closes, the installation is complete.

The **power LED** (bottom LED) blinks during device detection and initialization, and then remains on as long as the USB-2533 has sufficient power. If the power provided from the USB is not sufficient, the LED turns off, indicating you need a PS-9V1AEPS-2500 power supply.

When the board is first powered on, there is usually a momentary delay before the power LED blinks or turns on.

Connect external power, if used, before connecting the USB cable to the computer

If you are using a PS-9V1AEPS-2500 power supply, connect the external power cable to the USB-2533 before connecting the USB cable to the computer. This allows the USB-2533 to inform the host computer (when the USB cable is connected) that the board requires minimal power from the computer's USB port.

In general, all standoffs should be used to mount the board to a metal frame.

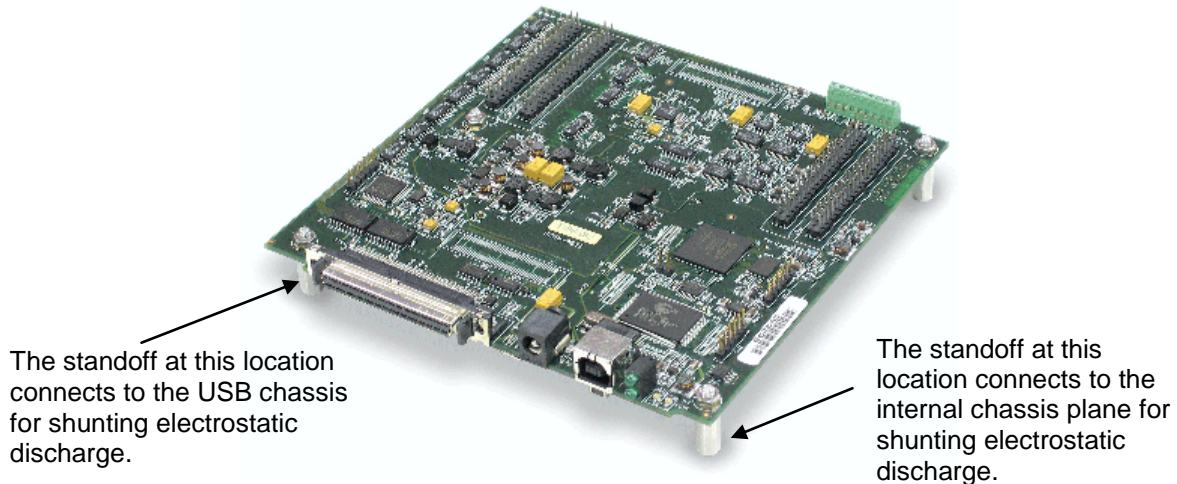

Caution! Do not disconnect any device from the USB bus while the computer is communicating with the USB-2533, or you may lose data and/or your ability to communicate with the USB-2533.

Configuring the hardware

All hardware configuration options on the USB-2533 are software-controlled. You can select some of the configuration options using InstaCal, such as the analog input configuration (64 single-ended or 32 differential channels), and the edge used for pacing when using an external clock. Once selected, any program that uses the Universal Library initializes the hardware according to these selections.

You need a PS-9V1AEPS-2500 power supply (sold separately) when there is insufficient power from the USB port. However, you can use this power supply in any scenario.

Caution! Avoid redundant connections. Ensure there is no signal conflict between SCSI pins and the associated header pin (J5 - J8). Also make sure there is no conflict between the TB7 TC connections and the SCSI and/or the 40-pin header connections.

Failure to do so could possibly cause equipment damage and/or personal injury.

Also, turn off power to all devices connected to the system before making connections. Electrical shock or damage to equipment can result even under low-voltage conditions.

Information on signal connections

General information regarding signal connection and configuration is available in the *Guide to DAQ Signal Connections*. This document is available for download from www.mccdaq.com/support/DAQ-Signal-Connections.aspx.

Caution! Always handle components carefully, and never touch connector pins or circuit components unless you are following ESD guidelines in an appropriate ESD-controlled area. These guidelines include using properly-grounded mats and wrist straps, ESD bags and cartons, and related procedures.

Avoid touching board surfaces and onboard components. Only handle boards by their edges. Make sure the USB-2533 does not come into contact with foreign elements such as oils, water, and industrial particulate.

The discharge of static electricity can damage some electronic components. Semiconductor devices are especially susceptible to ESD damage.

Signal connections

The following table lists board connectors, applicable cables, and compatible accessory products.

Board connectors, cables, and compatible hardware

Parameter	Specification
Connector types	Main connector: 68-pin standard "SCSI type III" female connector Auxiliary connectors: Four, 40-pin header connectors
Compatible cables	68-pin SCSI connector: <ul style="list-style-type: none"> ■ CA-68-3R — 68-pin ribbon cable; 3 feet. ■ CA-68-3S — 68-pin shielded round cable; 3 feet. ■ CA-68-6S — 68-pin shielded round cable; 6 feet 40-pin header connectors: <ul style="list-style-type: none"> ■ C40FF-x
Compatible accessory products	Using CA-68-3R, CA-68-3S, or CA-68-6S cables: <ul style="list-style-type: none"> ■ TB-100 terminal board Using the C40FF-x cable: <ul style="list-style-type: none"> ■ CIO-MINI40 Terminal board: <ul style="list-style-type: none"> ■ TB-101; mounts directly onto the header connectors

68-pin SCSI connector (P5)

The 68-pin SCSI connector—labeled P5 on the board—provides 16 single-ended analog channels or eight differential analog channels. Refer to the "40-pin header connector" section starting on page 13 to learn the pinouts for accessing up to 64 single-ended/32 differential analog channels using the P5 and P6 connectors.

Caution! Avoid redundant connections. Make sure there is no signal conflict among the SCSI pins, the 40-pin header connector pins (J5 - J8), and the TB7 TC connections. Failure to do so could possibly cause equipment damage and/or personal injury.

SCSI connector P5 single-ended pinout

Signal name	Pin		Pin	Signal name
ACH0	68	••	34	ACH8
AGND	67	••	33	ACH1
ACH9	66	••	32	AGND
ACH2	65	••	31	ACH10
AGND	64	••	30	ACH3
ACH11	63	••	29	AGND
SGND	62	••	28	ACH4
ACH12	61	••	27	AGND
ACH5	60	••	26	ACH13
AGND	59	••	25	ACH6
ACH14	58	••	24	AGND
ACH7	57	••	23	ACH15
NC	56	••	22	NC
NC	55	••	21	NC
NEGREF (reserved for self-calibration)	54	••	20	POSREF (reserved for self-calibration)
GND	53	••	19	+5 V
A1	52	••	18	A0
A3	51	••	17	A2
A5	50	••	16	A4
A7	49	••	15	A6
B1	48	••	14	B0
B3	47	••	13	B2
B5	46	••	12	B4
B7	45	••	11	B6
C1	44	••	10	C0
C3	43	••	9	C2
C5	42	••	8	C4
C7	41	••	7	C6
GND	40	••	6	TTL TRG
CNT1	39	••	5	CNT0
CNT3	38	••	4	CNT2
TMR1	37	••	3	TMR0
GND	36	••	2	XAPCR
GND	35	••	1	XDPCR

SCSI connector P5 differential pinout

Signal name	Pin	Pin	Signal name
ACH0 HI	68	34	ACH0 LO
AGND	67	33	ACH1 HI
ACH1 LO	66	32	AGND
ACH2 HI	65	31	ACH2 LO
AGND	64	30	ACH3 HI
ACH3 LO	63	29	AGND
SGND	62	28	ACH4 HI
ACH4 LO	61	27	AGND
ACH5 HI	60	26	ACH5 LO
AGND	59	25	ACH6 HI
ACH6 LO	58	24	AGND
ACH7 HI	57	23	ACH7 LO
NC	56	22	NC
NC	55	21	NC
NEGREF (reserved for self-calibration)	54	20	POSREF (reserved for self-calibration)
GND	53	19	+5 V
A1	52	18	A0
A3	51	17	A2
A5	50	16	A4
A7	49	15	A6
B1	48	14	B0
B3	47	13	B2
B5	46	12	B4
B7	45	11	B6
C1	44	10	C0
C3	43	9	C2
C5	42	8	C4
C7	41	7	C6
GND	40	6	TTL TRG
CNT1	39	5	CNT0
CNT3	38	4	CNT2
TMR1	37	3	TMR0
GND	36	2	XAPCR
GND	35	1	XDPCR

TB-100 terminal board connector to SCSI connector pinout

SCSI connector pinout assignments for TB-100
(differential analog signals in parentheses)

TB2 screw terminal	SCSI pin	TB1 screw terminal	SCSI pin
+5V	19	ACH0 (ACH0 HI)	68
GND	*	ACH8 (ACH0 LO)	34
A0	18	AGND	**
A1	52	ACH1 (ACH1 HI)	33
A2	17	ACH9 (ACH1 LO)	66
A3	51	AGND	**
A4	16	ACH2 (ACH2 HI)	65
A5	50	ACH10 (ACH2 LO)	31
A6	15	AGND	**
A7	49	ACH3 (ACH3 HI)	30
B0	14	ACH11 (ACH3 LO)	63
B1	48	AGND	**
B2	13	ACH4 (ACH4 HI)	28
B3	47	ACH12 (ACH4 LO)	61
B4	12	AGND	**
B5	46	ACH5 (ACH5 HI)	60
B6	11	ACH13 (ACH5 LO)	26
B7	45	AGND	**
C0	10	ACH6 (ACH6 HI)	25
C1	44	ACH14 (ACH6 LO)	58
C2	9	AGND	**
C3	43	ACH7 (ACH7 HI)	57
C4	8	ACH15 (ACH7 LO)	23
C5	42	NC	56
C6	7	SGND	62
C7	41	POSREF (reserved for self-calibration)	20
TTLTRG	6	NC	55
GND	*	NEGREF (reserved for self-calibration)	54
CNT0	5	AGND	**
CNT1	39	NC	22
CNT2	4	AGND	**
CNT3	38	NC	21
TMR0	3	AGND	**
TMR1	37	XAPCR	2
XDPCR	1	GND	**
GND	*	EGND	†

* Digital common ground pins on the SCSI connector are: 35, 36, and 40.
 ** Analog common ground pins on the SCSI connector are: 24, 27, 29, 32, 59, 64, and 67.
 † EGND is connected to the SCSI connector shell.

40-pin header connectors (J5, J6, J7, J8)

Analog channels pinout (J5 and J6)

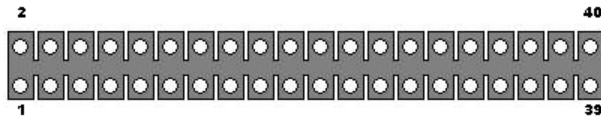

















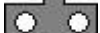

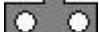

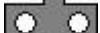

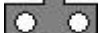

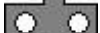

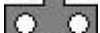

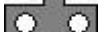

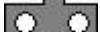

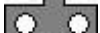



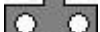

This edge of the header is closest to the center of the board. Pins 2 and 40 are labeled on the board silkscreen.

Header connector J5 and J6 single-ended pinout

Analog channel	Pin	J5	Pin	Analog channel	Analog channel	Pin	J6	Pin	Analog channel
ACH27	1		2	ACH19	ACH43	1		2	ACH59
ACH26	3		4	ACH18	ACH35	3		4	ACH51
AGND	5		6	AGND	AGND	5		6	ACH58
ACH3	7		8	ACH11	ACH42	7		8	ACH50
ACH2	9		10	ACH10	ACH34	9		10	ACH57
ACH17	11		12	ACH25	AGND	11		12	ACH49
ACH16	13		14	ACH24	ACH41	13		14	ACH56
ACH1	15		16	ACH9	ACH33	15		16	ACH48
ACH0	17		18	ACH8	ACH40	17		18	AGND
AGND	19		20	AGND	ACH32	19		20	ACH63
ACH23	21		22	ACH31	ACH47	21		22	ACH55
ACH22	23		24	ACH30	ACH39	23		24	AGND
ACH7	25		26	ACH15	ACH46	25		26	ACH62
ACH6	27		28	ACH14	ACH38	27		28	ACH54
AGND	29		30	ACH21	AGND	29		30	ACH61
ACH29	31		32	ACH20	ACH45	31		32	ACH53
ACH28	33		34	ACH5	ACH37	33		34	ACH60
ACH13	35		36	ACH4	ACH44	35		36	ACH52
ACH12	37		38	AGND	ACH36	37		38	AGND
AGND	39		40	AGND	AGND	39		40	AGND

































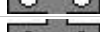







Header connector J5 and J6 differential pinout

Analog channel	Pin	J5	Pin	Analog channel	Analog channel	Pin	J6	Pin	Analog channel
ACH11 LO	1		2	ACH11 HI	ACH19 LO	1		2	ACH27 LO
ACH10 LO	3		4	ACH10 HI	ACH19 HI	3		4	ACH27 HI
AGND	5		6	AGND	AGND	5		6	ACH26 LO
ACH3 HI	7		8	ACH3 LO	ACH18 LO	7		8	ACH26 HI
ACH2 HI	9		10	ACH2 LO	ACH18 HI	9		10	ACH25 LO
ACH9 HI	11		12	ACH9 LO	AGND	11		12	ACH25 HI
ACH8 HI	13		14	ACH8 LO	ACH17 LO	13		14	ACH24 LO
ACH1 HI	15		16	ACH1 LO	ACH17 HI	15		16	ACH24 HI
ACH0 HI	17		18	ACH0 LO	ACH16 LO	17		18	AGND
AGND	19		20	AGND	ACH16 HI	19		20	ACH31 LO
ACH15 HI	21		22	ACH15 LO	ACH23 LO	21		22	ACH31 HI
ACH14 HI	23		24	ACH14 LO	ACH23 HI	23		24	AGND
ACH7 HI	25		26	ACH7 LO	ACH22 LO	25		26	ACH30 LO
ACH6 HI	27		28	ACH6 LO	ACH22 HI	27		28	ACH30 HI
AGND	29		30	ACH13 HI	AGND	29		30	ACH29 LO
ACH13 LO	31		32	ACH12 HI	ACH21 LO	31		32	ACH29 HI
ACH12 LO	33		34	ACH5 HI	ACH21 HI	33		34	ACH28 LO
ACH5 LO	35		36	ACH4 HI	ACH20 LO	35		36	ACH28 HI
ACH4 LO	37		38	AGND	ACH20 HI	37		38	AGND
AGND	39		40	AGND	AGND	39		40	AGND

Digital ports, counters, timers, triggers, and pacer clocks pinout (J7 and J8)

You can use the 40-pin connector headers labeled J7 and J8 to connect digital ports, counters, timers, triggers, pacer clocks, and other signals.

Header connector J7 and J8 pinout

Digital channel	Pin	J7	Pin	Digital channel	Signal	Pin	J8	Pin	Signal
GND	1		2	XAPCR	+13 V	1		2	-13 V
A0	3		4	A4	NC	3		4	NC
A1	5		6	A5	AGND	5		6	AGND
A2	7		8	A6	NC	7		8	NC
A3	9		10	A7	NC	9		10	NC
GND	11		12	TTL TRG	AGND	11		12	AGND
B0	13		14	B4	SelfCal	13		14	SGND
B1	15		16	B5	AGND	15		16	AGND
B2	17		18	B6	TTL TRG	17		18	XDPCR
B3	19		20	B7	XAPCR	19		20	GND (digital)
GND	21		22	+5 V	GND (digital)	21		22	GND (digital)
C0	23		24	C4	NC	23		24	NC
C1	25		26	C5	+5 V	25		26	AUX PWR
C2	27		28	C6	NC	27		28	NC
C3	29		30	C7	NC	29		30	NC
GND	31		32	TMR1	NC	31		32	NC
TMR0	33		34	CNT1	NC	33		34	NC
CNT0	35		36	CNT3	NC	35		36	NC
CNT2	37		38	GND	NC	37		38	NC
GND	39		40	GND	NC	39		40	NC

Using C40FF-x cables to obtain 40-pin female connectors

In this example, a C40FF-x cable is connected to all of the 40-pin headers (J5, J6, J7, and J8). The result is four female 40-pin connectors that together have more signal connectivity than the SCSI connector.

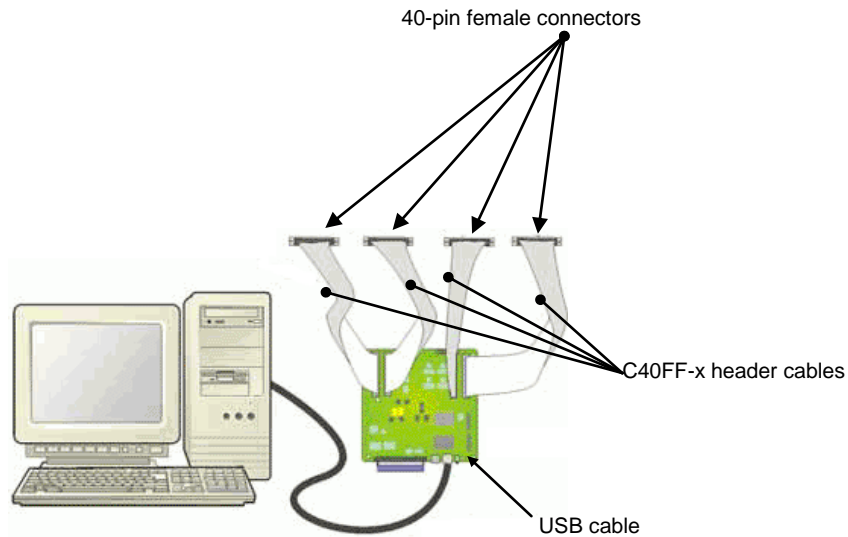

Figure 1. Four C40FF-x cables connected to J5 through J8 40-pin connectors

Four-channel TC terminal block (TB7)

You can use the TB7 terminal block to connect up to four thermocouples. The first TC channel uses ACH0 (analog channel 0) for its positive (+) lead, and ACH8 for its negative (-) lead. The second TC channel uses ACH1 and ACH9, and so on, as indicated in Figure 2.

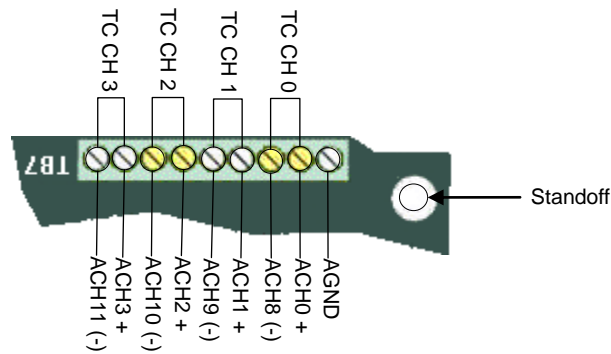

Figure 2. TB7 pinout

Cabling

Use a CA-68-3R 68-pin ribbon expansion cable (Figure 3), or a CA-68-3S (3-foot) or CA-68-6S (6-foot) 68-pin shielded expansion cable (Figure 4) to connect signals to the 68-pin SCSI connector.

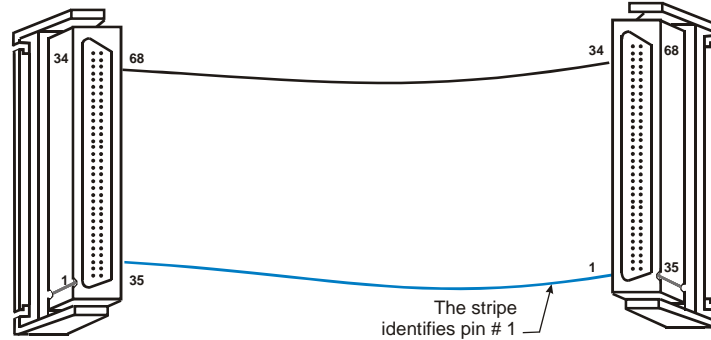

Figure 3. CA-68-3R cable

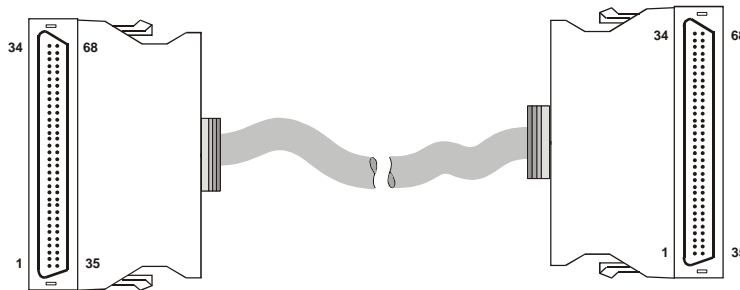

Figure 4. CA-68-3S and CA-68-6S cable

Use one or more C40FF-x- ribbon cable(s) (Figure 5) to connect signals to one or more of the 40-pin header connectors.

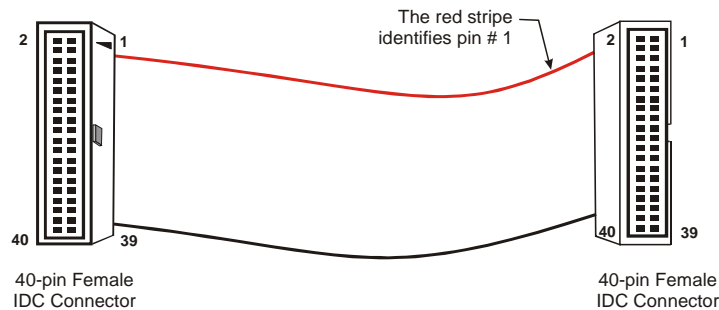

Figure 5. C40FF-x cable

Field wiring and signal termination

You can use the following screw terminal board to terminate field signals and route them into the USB-2533 board using the CA-68-3R, CA-68-3S, or CA-68-6S cable:

- **TB-100:** Termination board with screw terminals.
A 19-inch rack mount kit (**RM-TB-100**) for the TB-100 termination board is also available.

You can use the following screw terminal board with the C40FF-x cable.

- **CIO-MINI40:** 40-pin screw terminal board.

Details on these products are available on our web site.

Functional Details

This chapter contains detailed information on all of the features available from the board, including:

- a diagram and explanations of physical board components
- a functional block diagram
- information on how to use the signals generated by the board
- diagrams of signals using default or conventional board settings

Board components

These USB-2533 components are shown in Figure 6.

- One USB port
- One external power connector
- One 68-pin SCSI connector
- Four 40-pin headers (J5, J6, J7, and J8)
- One four-channel TC screw terminal block
- Two LED indicators (USB and power)

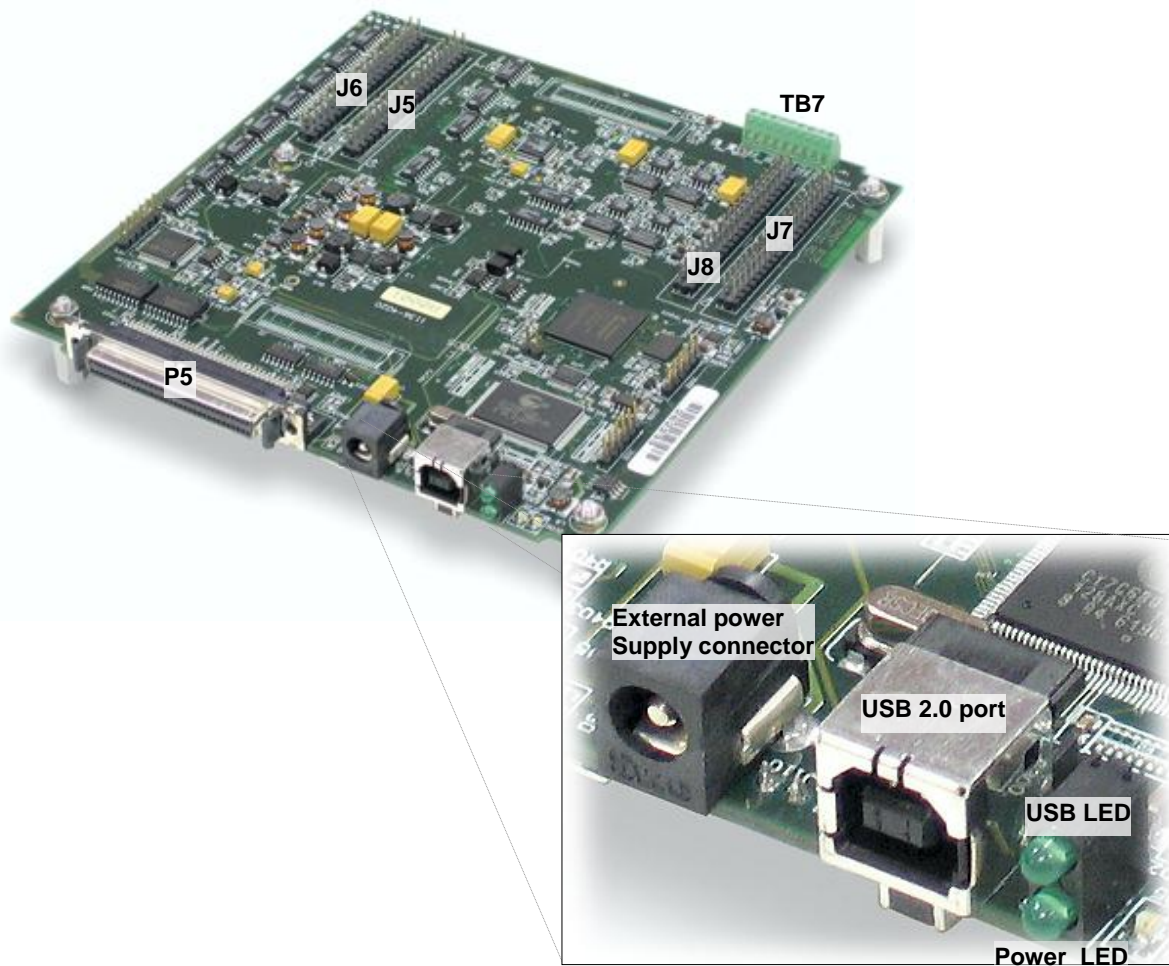

Figure 6. USB-2533 components

SCSI - 68 pin (P5) connector

The 68-pin SCSI connector includes pins for the following:

- 16 single-ended/eight differential analog inputs (64 single-ended/32 differential analog inputs available only from J5 and J6 40-pin connectors)
- 24 digital I/O
- Four counter inputs
- Two timer outputs
- Input scan pacer clock I/O
- Output scan pacer clock I/O
- TTL trigger
- self calibration
- +5 VDC
- analog commons
- digital commons

40-pin headers (J5, J6, J7, J8)

The four 40-pin headers provide alternative connections to the SCSI connector signals. You can get a female connector for each header by connecting a C40FF-x cable to each header.

9-slot screw terminal (TB7)

You can use the on-board screw terminal connector (TB7) to connect up to four TC inputs. TB7 uses the following analog channels to obtain its four differential channels:

- TC CH0: CH 0 (+); CH 8 (-)
- TC CH1: CH 1 (+); CH 9 (-)
- TC CH2: CH 2 (+); CH 10 (-)
- TC CH3: CH 3 (+); CH 11 (-)

When using the thermocouple channels, do not connect signals to the associated channels on the SCSI connector or J5.

External power connector

Although the USB-2533 is powered by a USB port on a host PC, an external power connector is available when the host PC's USB port cannot supply adequate power, or if you prefer to use a separate power source.

Connect the optional PS-9V1AEPS-2500 power supply to the external power supply connector. This power supply plugs into a standard 120 VAC outlet and supplies 9 VDC, 1 A power to the USB-2533.

Functional block diagram

Device functions are illustrated in the block diagram shown in Figure 7.

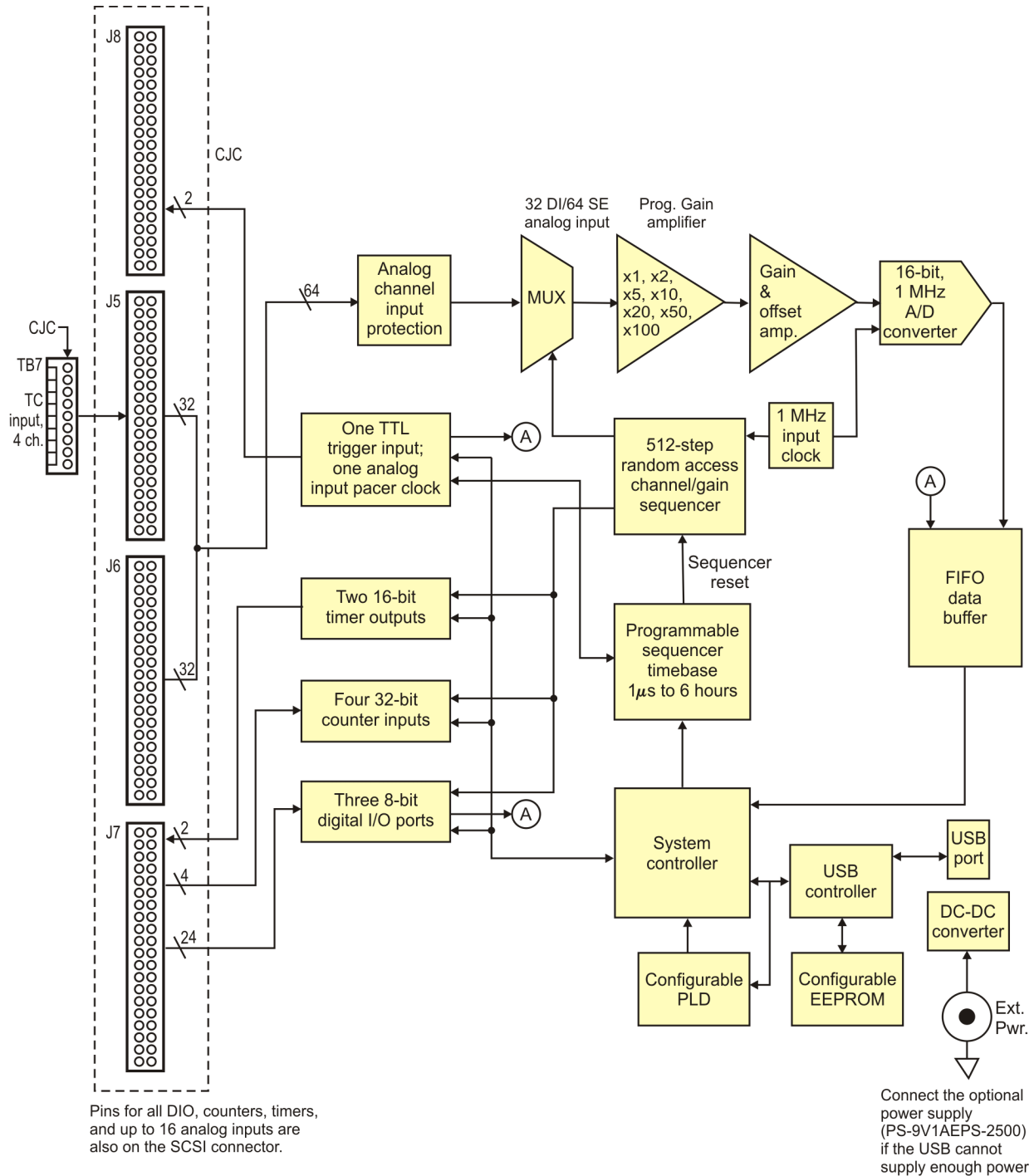

Figure 7. USB-2533 functional block diagram

Synchronous I/O – mixing analog, digital, and counter scanning

The USB-2533 can read analog, digital, and counter inputs, while generating digital pattern outputs at the same time. Digital and counter inputs do not affect the overall A/D rate because these inputs use no time slot in the scanning sequencer.

For example, one analog input channel can be scanned at the full 1 MHz A/D rate along with digital and counter input channels. Each analog channel can have a different gain, and counter and digital channels do not need additional scanning bandwidth as long as there is at least one analog channel in the scan group.

Digital input channel sampling is not done during the "dead time" of the scan period where no analog sampling is being done either.

Analog input

The USB-2533 has a 16-bit, 1-MHz A/D coupled with 64 single-ended, or 32 differential analog inputs. Seven software programmable ranges provide inputs from ± 10 V to ± 100 mV full scale.

Analog input scanning

The USB-2533 has several scanning modes to address various applications. You can load the 512-location scan buffer with any combination of analog input channels. All analog input channels in the scan buffer are measured sequentially at 1 μ s per channel by default.

For example, in the fastest mode, with a 1 μ s settling time for the acquisition of each channel, a single analog channel can be scanned continuously at 1 MS/s; two analog channels can be scanned at 500 kS/s each; 16 analog input channels can be scanned at 62.5 kS/s.

Settling time

For most applications, leave the settling time at its default of 1 μ s.

However, if you are scanning multiple channels, and one or more channels are connected to a high-impedance source, you may get better results by increasing the settling time. Remember that increasing the settling reduces the maximum acquisition rate.

You can set the settling time to 1 μ s, 5 μ s, 10 μ s, or 1 ms.

Example: Analog channel scanning of voltage inputs

Figure 8 shows a simple acquisition. The scan is programmed pre-acquisition and is made up of six analog channels (Ch0, Ch1, Ch3, Ch4, Ch6, and Ch7). Each of these analog channels can have a different gain. The acquisition is triggered and the samples stream to the PC. Using the default settling time, each analog channel requires one microsecond of scan time—therefore the scan period can be no shorter than 6 μ s for this example. The scan period can be made much longer than 6 μ s—up to 1 s. The maximum scan frequency is 1 divided by 6 μ s, or 166,666 Hz.

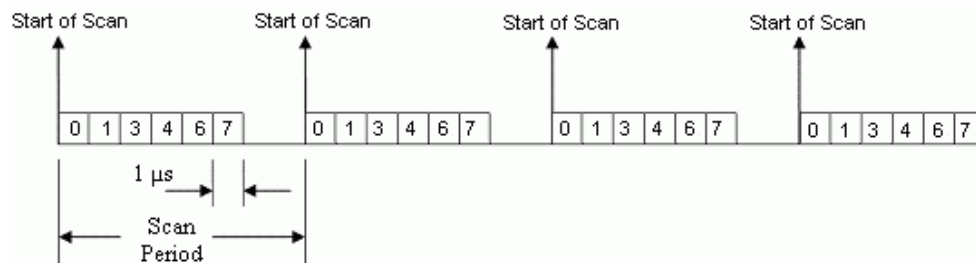

Figure 8. Analog channel scan of voltage inputs example

Example: Analog channel scanning of voltage and temperature inputs

Figure 9 shows a programmed pre-acquisition scan made up of six analog channels (Ch0, Ch1, Ch5, Ch11, Ch12, Ch13). Each of these analog channels can have a different gain. You can program channels 0 and 1 to directly measure TCs.

In this mode, oversampling is programmable up to 16384 oversamples per channel in the scan group. When oversampling is applied, it is applied to all analog channels in the scan group, including temperature and voltage channels. Digital channels are not oversampled.

If you want 256 oversamples, then each analog channel in the scan group takes 256 μ s, and the returned 16-bit value represents an average of 256 consecutive 1 μ s samples of that channel. The acquisition is triggered and 16-bit values—each representing an average of 256—stream to the PC via the USB cable. Since two of the channels in the scan group are temperature channels, you need the acquisition engine to read a cold-junction-compensation (CJC) temperature every scan.

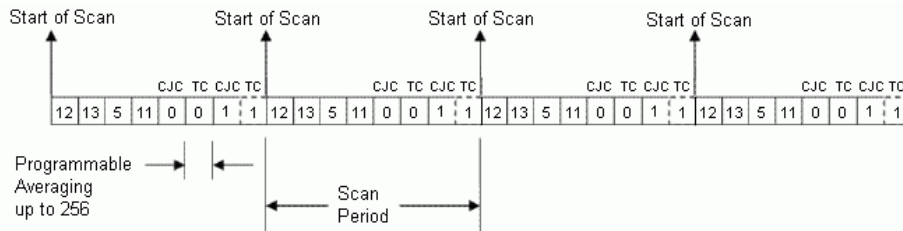

Figure 9. Analog channel scanning of voltage and temperature inputs example

Since the targeted number of oversamples is 256 in this example, each analog channel in the scan group requires 256 microseconds to return one 16-bit value. The oversampling is also done for CJC temperature measurement channels, making the minimum scan period for this example 7 X 256 μ s, or 1792 μ s. The maximum scan frequency is the inverse of this number, 558 Hz.

For accurate measurements, you must associate TC and CJC channels properly
 The TC channels must immediately follow their associated CJC channels in the channel array. For accurate TC readings, associate CJC0 with TC0, CJC1 with TC1 and TC2, and CJC2 with TC3.

Example: Analog and digital scanning, once per scan mode

The scan is programmed pre-acquisition and is made up of six analog channels (Ch0, Ch2, Ch5, Ch11, Ch13, Ch15) and four digital channels (16-bits of digital IO, three counter inputs.) Each of the analog channels can have a different gain.

The acquisition is triggered and the samples stream to the PC via the USB cable. Each analog channel requires one microsecond of scan time. Therefore, the scan period can be no shorter than 6 μ s for this example. All of the digital channels are sampled at the start of scan and do not require additional scanning bandwidth as long as there is at least one analog channel in the scan group. The scan period can be made much longer than 6 μ s, up to 1 second. The maximum scan frequency is one divided by 6 μ s, or 166,666 Hz.

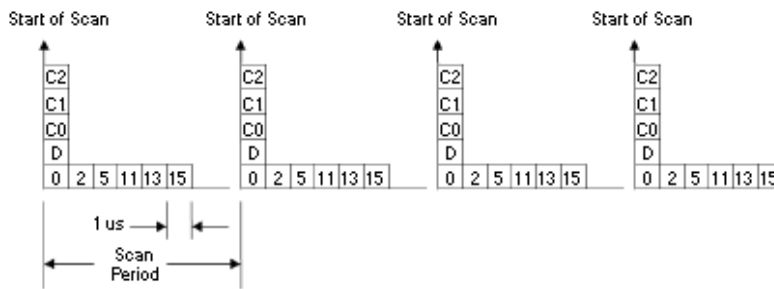

Figure 10. Analog and digital scanning, once per scan mode example

The counter channels may return only the lower 16-bits of count value if that is sufficient for the application. They could also return the full 32-bit result if necessary. Similarly, the digital input channel could be the full 24 bits if desired or only eight bits if that is sufficient. If the three counter channels are all returning 32-bit values and the digital input channel is returning a 16-bit value, then 13 samples are being returned to the PC every scan period, with each sample being 16-bits. The 32-bit counter channels are divided into two 16-bit samples—one for the low word, and the other for the high word. If the maximum scan frequency is 166,666 Hz, then the data bandwidth streaming into the PC is 2.167 MS/s. Some slower PCs may have a problem with data bandwidths greater than 6 MS/s. The USB-2533 has an onboard 1 MS buffer for acquired data.

Example: Sampling digital inputs for every analog sample in a scan group

The scan is programmed pre-acquisition and is made up of six analog channels (Ch0, Ch2, Ch5, Ch11, Ch13, Ch15) and four digital channels (16-bits of digital input, three counter inputs.) Each of the analog channels can have a different gain.

The acquisition is triggered and the samples stream to the PC via the USB cable. Each analog channel requires one microsecond of scan time therefore the scan period can be no shorter than 6 μ s for this example. All of the digital channels are sampled at the start of scan and do not require additional scanning bandwidth as long as there is at least one analog channel in the scan group. The 16-bits of digital input are sampled for every analog sample in the scan group. This allows up to 1 MHz digital input sampling while the 1 MHz analog sampling bandwidth is aggregated across many analog input channels.

The scan period can be made much longer than 6 μ s—up to 1 second. The maximum scan frequency is one divided by 6 μ s, or 166,666 Hz. Note that digital input channel sampling is not done during the "dead time" of the scan period where no analog sampling is being done either.

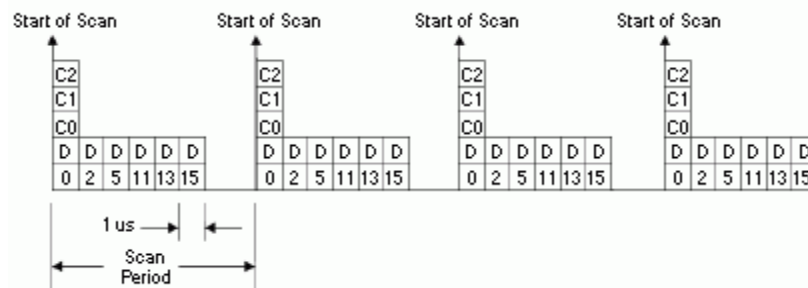

Figure 11. Analog and digital scanning, once per scan mode example

If the three counter channels are all returning 32-bit values and the digital input channel is returning a 1-bit value, then 18 samples are returned to the PC every scan period, with each sample being 16-bits. Each 32-bit counter channel is divided into two 16-bit samples—one for the low word and the other for the high word. If the maximum scan frequency is 166,666 Hz, then the data bandwidth streaming into the PC is 3 MS/s. Some slower PCs may have a problem with data bandwidths greater than 6 MS/s.

The USB-2533 has an onboard 1 MS buffer for acquired data.

Thermocouple input

You can configure up to four analog inputs on the USB-2533 to accept a TC input. Built-in cold-junction sensors are provided for each of the screw-terminal connectors, and any TC type can be attached to any of the four thermocouple channels.

When measuring TCs, the USB-2533 can operate in an averaging mode, taking multiple readings on each channel, applying digital filtering and cold-junction compensation, and then converting the readings to temperature.

As a result, the USB-2533 measures channels with TCs attached at a rate from 50 Hz to 10 kHz, depending on how much over-sampling is selected.

Additionally, a rejection frequency can be specified in which over sampling occurs during one cycle of either 50 Hz or 60 Hz, providing a high level of 50 Hz or 60 Hz rejection.

Tips for making accurate temperature measurements

- Use as much oversampling as possible.
- Warm up the USB-2533 for 60 minutes—including TC wires—so that it is thermally stabilized. This warm-up time enables the CJC thermistors to more accurately measure the junction at the terminal block.
- Make sure the surrounding environment is thermally stabilized and ideally around 20 °C to 30 °C. If the board's ambient temperature is changing due to a local heating or cooling source, then the TC junction temperature may be changing and the CJC thermistor will have a larger error.
- Use small-diameter, *instrument-grade* TC wire. Small diameter TC wire has less effect on the TC junction at the terminal block because less heat is transferred from the ambient environment to the junction.
- Use shielded TC wire (see "Shielding" below) with the shield connected to analog common to reduce noise. The USB-2533 has several analog common pins on both the 68-pin connector and the 40-pin connectors, and the TB-7 has one analog common screw terminal.

You can also minimize the effect of noise by averaging readings (see "Averaging" below), or combining both shielding and averaging.

Refer to "68-pin SCSI connector (P5)" on page 13, "40-pin header connector" on page 13, and "Four-channel TC terminal block (TB7)" on page 16 for the locations of these analog common pins.

- Make sure the USB-2533 is mounted on a flat surface.
- Be careful to avoid loading down the digital outputs too heavily (>1 mA). Heavy load down causes significant heat generation inside the unit and increase the CJC thermistor error.

Shielding

Use shielded TC wire with the shield connected to analog common to further reduce noise.

The USB-2533 has one analog common screw-terminal on TB7 and several analog common pins on the headers. You can connect the shield of a shielded thermocouple to one of the analog commons. When this connection is made, leave the shield at the other end of the thermocouple unconnected.

Caution! Connecting the shield to common at both ends results in a ground loop.

Averaging

Certain acquisition programs apply *averaging* after several samples have been collected. Depending on the nature of the noise, averaging can reduce noise by the square root of the number of averaged samples.

Although averaging can be effective, it suffers from several drawbacks.

- Noise in measurements only decreases as the square root of the number of measurements—reducing RMS noise significantly may require many samples. Thus, averaging is suited to low-speed applications that can provide many samples.
- Only random noise is reduced or eliminated by averaging. Averaging does not reduce or eliminate periodic signals.

Digital I/O

Twenty-four TTL-level digital I/O lines are included in each USB-2533. You can program digital I/O in 8-bit groups as either inputs or outputs and scan them in several modes (see "Digital input scanning" below). You can access input ports asynchronously from the PC at any time, including when a scanned acquisition is occurring.

Digital input scanning

Digital input ports can be read asynchronously before, during, or after an analog input scan. Digital input ports can be part of the scan group and *scanned along with analog input channels*.

Two synchronous modes are supported when digital inputs are scanned along with analog inputs. Refer to "[Example 4: Sampling digital inputs for every analog sample in a scan group](#)" on page 23 for more information. In both modes, adding digital input scans has no effect on the analog scan rate limitations. If no analog inputs are being scanned, the digital inputs can sustain rates up to 4 MHz. Higher rates—up to 12 MHz—are possible depending on the platform and the amount of data being transferred.

Digital outputs and pattern generation

Digital outputs can be updated asynchronously anytime before, during, or after an acquisition. You can use two of the 8-bit ports to generate a digital pattern at up to 4 MHz. The USB-2533 supports digital pattern generation. The digital pattern can be read from PC RAM.

Higher rates—up to 12 MHz—are possible depending on the platform and the amount of data being transferred.

Digital pattern generation is clocked using an internal clock. The on-board programmable clock generates updates ranging from once every 1 second to 1 MHz, independent of any acquisition rate.

Triggering

Triggering can be the most critical aspect of a data acquisition application. The USB-2533 supports the following trigger modes to accommodate certain measurement situations.

Hardware analog triggering

The USB-2533 uses true analog triggering in which the trigger level you program sets an analog DAC, which is then compared in hardware to the analog input level on the selected channel. This guarantees an analog trigger latency that is less than 1 μ s.

You can select any analog channel as the trigger channel, but the selected channel must be the first channel in the scan. You can program the trigger level, the rising or falling edge, and hysteresis.

A note on the hardware analog level trigger and comparator change state

When analog input voltage starts near the trigger level, and you are performing a rising or falling hardware analog level trigger, the analog level comparator may have already tripped before the sweep was enabled. If this is the case, the circuit waits for the comparator to change state. However, since the comparator has already changed state, the circuit does not see the transition.

To resolve this problem, do the following:

1. Set the analog level trigger to the threshold you want.
2. Apply an analog input signal that is *more than* 2.5% of the full-scale range *away from the desired threshold*. This ensures that the comparator is in the proper state at the beginning of the acquisition.
3. Bring the analog input signal toward the desired threshold. When the input signal is at the threshold (\pm some tolerance) the sweep will be triggered.
4. Before re-arming the trigger, move the analog input signal to a level that is more than 2.5% of the full-scale range *away from* the desired threshold.

For example, if you are using the ± 2 V full-scale range (gain = 5), and you want to trigger at +1 V on the rising edge, you would set the analog input voltage to a start value that is less than +0.9 V ($1 \text{ V} - (2 \text{ V} * 2 * 2.5\%)$).

Digital triggering

A separate digital trigger input line is provided (TTL TRG), allowing TTL-level triggering with latencies guaranteed to be less than 1 μ s. You can program both of the logic levels (1 or 0) and the rising or falling edge for the discrete digital trigger input.

Software-based triggering

The three software-based trigger modes differ from hardware analog triggering and digital triggering because the readings—analogue, digital, or counter—are checked by the PC in order to detect the trigger event.

Analog triggering

You can select any analog channel in the scan as the trigger channel. You can program the trigger level, the rising or falling edge, and hysteresis.

Pattern triggering

You can select any scanned digital input channel pattern to trigger an acquisition, including the ability to mask or ignore specific bits.

Counter triggering

You can program triggering to occur when one of the counters meets or exceeds a set value, or is within a range of values. You can program any of the included counter channels as the trigger source.

Software-based triggering usually results in a long period of inactivity between the trigger condition being detected and the data being acquired. However, the USB-2533 avoids this situation by using pre-trigger data. When software-based-triggering is used, and the PC detects the trigger condition—which may be thousands of readings after the actual occurrence of the signal—the USB-2533 driver automatically looks back to the location in memory where the actual trigger-causing measurement occurred, and presents the acquired data that begins at the point where the trigger-causing measurement occurs. The maximum inactive period in this mode equals one scan period.

Set pre-trigger > 0 when using counter as trigger source

When using a counter for a trigger source, you should use a pre-trigger with a value of at least 1. Since all counters start at zero with the first scan, there is no valid reference in regard to rising or falling edge. Setting a pre-trigger to 1 or more ensures that a valid reference value is present, and that the first trigger will be legitimate.

Stop trigger modes

You can use any of the software trigger modes explained previously to stop an acquisition.

For example, you can program an acquisition to begin on one event—such as a voltage level—and then stop on another event—such as a digital pattern.

Pre-triggering and post-triggering modes

The USB-2533 supports four modes of pre-triggering and post-triggering, providing a wide-variety of options to accommodate any measurement requirement.

When using pre-trigger, you must use software-based triggering to initiate an acquisition.

No pre-trigger, post-trigger stop event

In this simple mode, data acquisition starts when the trigger is received, and the acquisition stops when the stop-trigger event is received.

Fixed pre-trigger with post-trigger stop event

In this mode, you set the number of pre-trigger readings to acquire. The acquisition continues until a stop-trigger event occurs.

No pre-trigger, infinite post-trigger

In this mode, no pre-trigger data is acquired. Instead, data is acquired beginning with the trigger event, and is terminated when you issue a command to halt the acquisition.

Fixed pre-trigger with infinite post-trigger

You set the amount of pre-trigger data to acquire. Then, the system continues to acquire data until the program issues a command to halt acquisition.

Counter inputs

Four 32-bit counters are built into the USB-2533. Each counter accepts frequency inputs up to 20 MHz.

USB-2533 counter channels can be configured as standard counters or as multi-axis quadrature encoders.

The counters can concurrently monitor time periods, frequencies, pulses, and other event driven incremental occurrences directly from pulse-generators, limit switches, proximity switches, and magnetic pick-ups.

Counter inputs can be read asynchronously under program control, or synchronously as part of an analog or digital scan group.

When reading synchronously, all counters are set to zero at the start of an acquisition. When reading asynchronously, counters may be cleared on each read, count up continually, or count until the 16 bit or 32 bit limit has been reached. See the counter mode descriptions below.

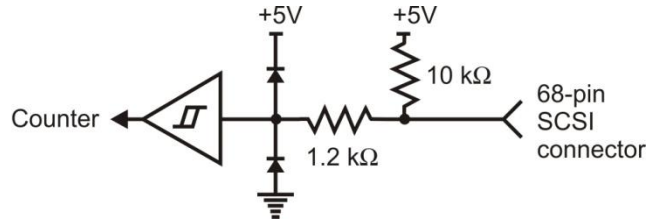

Figure 12. Typical USB-2533 counter channel

Mapped channels

A *mapped channel* is one of four counter input signals that can get multiplexed into a counter module. The mapped channel can participate with the counter's input signal by gating the counter, latching the counter, and so on. The four possible choices for the mapped channel are the four counter input signals (post-debounce).

A mapped channel can be used to:

- gate the counter
- decrement the counter
- latch the current count to the count register

Usually, all counter outputs are latched at the beginning of each scan within the acquisition. However, you can use a second mapped channel to latch the counter output.

Counter modes

A counter can be asynchronously read with or without *clear on read*. The asynchronous read-signals strobe when the lower 16-bits of the counter are read by software. The software can read the counter's high 16-bits some time later after reading the lower 16-bits. The full 32-bit result reflects the timing of the first asynchronous read strobe.

Totalize mode

The *Totalize mode* allows basic use of a 32-bit counter. While in this mode, the channel's input can only increment the counter upward. When used as a 16-bit counter (*counter low*), one channel can be scanned at the 12 MHz rate. When used as a 32-bit counter (*counter high*), two sample times are used to return the full 32-bit result. Therefore a 32-bit counter can only be sampled at a 6 MHz maximum rate. If you only want the upper 16 bits of a 32-bit counter, then you can acquire that upper word at the 12 MHz rate.

The counter counts up and does not clear on every new sample. However, it does clear at the start of a new scan command.

The counter rolls over on the 16-bit (*counter low*) boundary, or on the 32-bit (*counter high*) boundary.

Clear on read mode

The counter counts up and is cleared after each read. By default, the counter counts up and only clears the counter at the start of a new scan command. The final value of the counter—the value just before it was cleared—is latched and returned to the USB-2533.

Stop at the top mode

The counter stops at the top of its count. The top of the count is FFFF hex (65,535) for the 16-bit mode, and FFFFFFFF hex (4,294,967,295) for the 32-bit mode.

32-bit or 16-bit

Sets the counter type to either 16-bits or 32-bits. The type of counter only matters if the counter is using the stop at the top mode—otherwise, this option is ignored.

Latch on map

Sets the signal on the mapped counter input to latch the count.

By default, the *start of scan* signal—a signal internal to the USB-2533 pulses once every scan period to indicate the start of a scan group—latches the count, so the count is updated each time a scan is started.

Gating "on" mode

Sets the gating option to "on" for the mapped channel, enabling the mapped channel to gate the counter.

Any counter can be *gated* by the mapped channel. When the mapped channel is *high*, the counter is enabled. When the mapped channel is *low*, the counter is disabled (but holds the count value). The mapped channel can be any counter input channel other than the counter being gated.

Decrement "on" mode

Sets the counter decrement option to "on" for the mapped channel. The input channel for the counter increments the counter, and you can use the mapped channel to decrement the counter.

Debounce modes

Each channel's output can be debounced with 16 programmable debounce times from 500 ns to 25.5 ms. The debounce circuitry eliminates switch-induced transients typically associated with electro-mechanical devices including relays, proximity switches, and encoders.

There are two debounce modes, as well as a debounce bypass, as shown in Figure 13. In addition, the signal from the buffer can be inverted before it enters the debounce circuitry. The inverter is used to make the input rising-edge or falling-edge sensitive.

Edge selection is available with or without debounce. In this case the debounce time setting is ignored and the input signal goes straight from the inverter or inverter bypass to the counter module.

There are 16 different debounce times. In either debounce mode, the debounce time selected determines how fast the signal can change and still be recognized.

The two debounce modes are *trigger after stable* and *trigger before stable*. A discussion of the two modes follows.

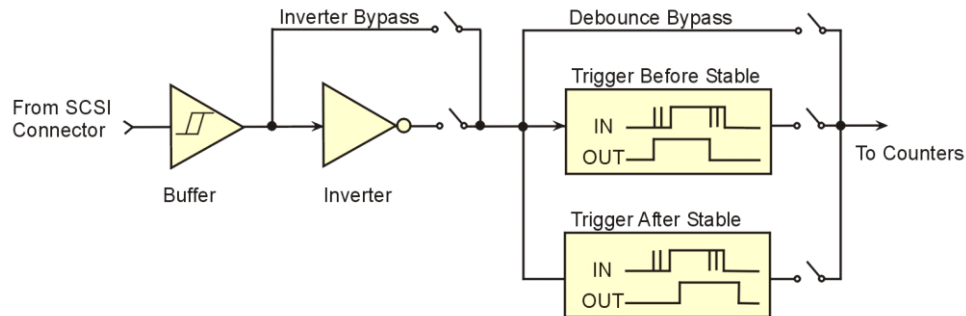

Figure 13. Debounce model block diagram

Trigger after stable mode

In the *trigger after stable* mode, the output of the debounce module does not change state until a period of stability has been achieved. This means that the input has an edge, and then must be stable for a period of time equal to the debounce time.

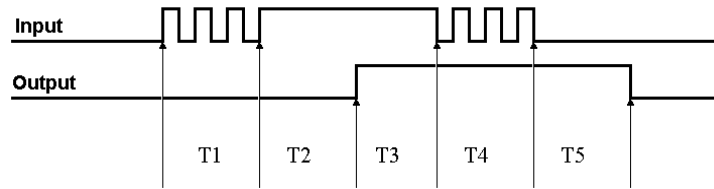

Figure 14. Debounce module – trigger after stable mode

The following time periods (T1 through T5) pertain to Figure 14. In *trigger after stable* mode, the input signal to the debounce module is required to have a period of stability after an incoming edge, in order for that edge to be accepted (passed through to the counter module.) The debounce time for this example is equal to T2 and T5.

- T1 – In the example above, the input signal goes high at the beginning of time period T1, but never stays high for a period of time equal to the debounce time setting (equal to T2 for this example.)
- T2 – At the end of time period T2, the input signal has transitioned high and stayed there for the required amount of time—therefore the output transitions high. If the input signal does not stabilize in the high state long enough, no transition would have appeared on the output and the entire disturbance on the input would have been rejected.
- T3 – During time period T3, the input signal remained steady. No change in output is seen.
- T4 – During time period T4, the input signal has more disturbances and does not stabilize in any state long enough. No change in the output is seen.
- T5 – At the end of time period T5, the input signal has transitioned low and stayed there for the required amount of time—therefore the output goes low.

Trigger before stable mode

In the *trigger before stable* mode, the output of the debounce module immediately changes state, but will not change state again until a period of stability has passed. For this reason the mode can be used to detect glitches.

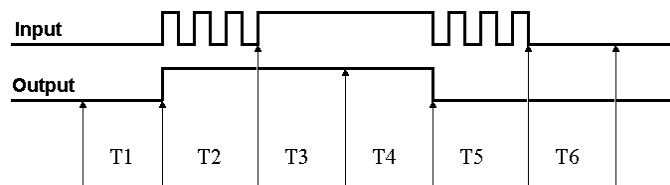

Figure 15. Debounce module – Trigger before stable mode

The following time periods (T1 through T6) pertain to the above drawing.

- T1 – In the illustrated example, the input signal is low for the debounce time (equal to T1); therefore when the input edge arrives at the end of time period T1, it is accepted and the output (of the debounce module) goes high. Note that a period of stability must precede the edge in order for the edge to be accepted.
- T2 – During time period T2, the input signal is not stable for a length of time equal to T1 (the debounce time setting for this example.) Therefore, the output stays "high" and does not change state during time period T2.
- T3 – During time period T3, the input signal is stable for a time period equal to T1, meeting the debounce requirement. The output is held at the high state. This is the same state as the input.
- T4 – At anytime during time period T4, the input can change state. When this happens, the output will also change state. At the end of time period T4, the input changes state, going low, and the output follows this action [by going low].
- T5 – During time period T5, the input signal again has disturbances that cause the input to not meet the debounce time requirement. The output does not change state.
- T6 – After time period T6, the input signal has been stable for the debounce time and therefore any edge on the input after time period T6 is immediately reflected in the output of the debounce module.

Debounce mode comparisons

Figure 16 shows how the two modes interpret the same input signal, which exhibits glitches. Notice that the *trigger before stable* mode recognizes more glitches than the *trigger after stable* mode. Use the *bypass* option to achieve maximum glitch recognition.

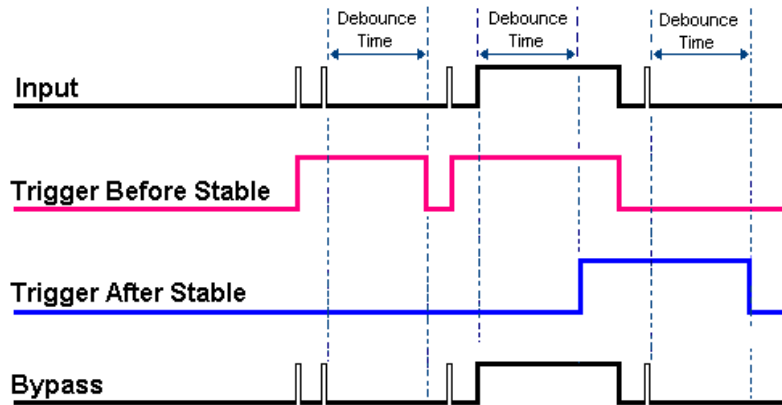

Figure 16. Example of two debounce modes interpreting the same signal

Debounce times should be set according to the amount of instability expected in the input signal. Setting a debounce time that is too short may result in unwanted glitches clocking the counter. Setting a debounce time too long may result in an input signal being rejected entirely. Some experimentation may be required to find the appropriate debounce time for a particular application.

To see the effects of different debounce time settings, simply view the analog waveform along with the counter output. This can be done by connecting the source to an analog input.

Use *trigger before stable* mode when the input signal has groups of glitches and each group is to be counted as one. The trigger before stable mode recognizes and counts the first glitch within a group but rejects the subsequent glitches within the group if the debounce time is set accordingly. The debounce time should be set to encompass one entire group of glitches as shown in the following diagram.

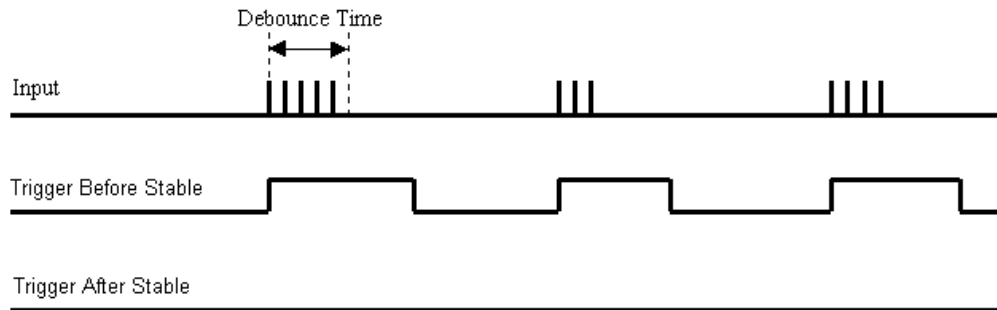

Figure 17. Optimal debounce time for trigger before stable mode

Trigger after stable mode behaves more like a traditional debounce function: rejecting glitches and only passing state transitions after a required period of stability. *Trigger after stable* mode is used with electro-mechanical devices like encoders and mechanical switches to reject switch bounce and disturbances due to a vibrating encoder that is not otherwise moving. The debounce time should be set short enough to accept the desired input pulse but longer than the period of the undesired disturbance as shown in Figure 18.

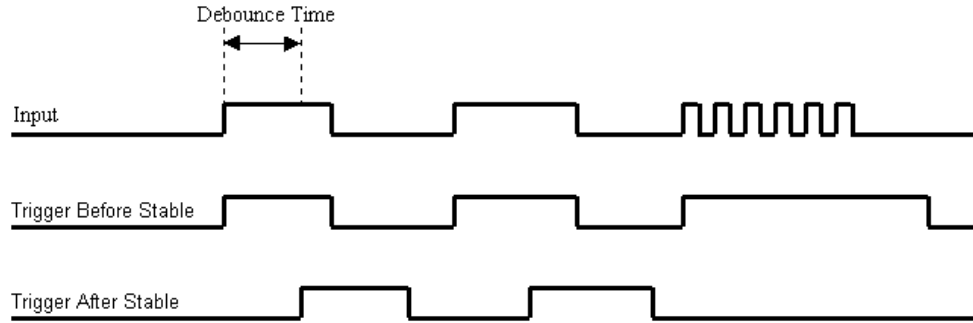

Figure 18. Optimal debounce time for trigger after stable mode

Encoder mode

Rotary shaft encoders are frequently used with CNC equipment, metal-working machines, packaging equipment, elevators, valve control systems, and in a multitude of other applications in which rotary shafts are involved.

The *encoder mode* allows the USB-2533 to make use of data from optical incremental quadrature encoders. In encoder mode, the USB-2533 accepts *single-ended* inputs. When reading phase A, phase B, and index Z signals, the USB-2533 provides positioning, direction, and velocity data.

The USB-2533 can receive input from up to two encoders.

The USB-2533 supports quadrature encoders with a 16-bit (counter low) or a 32-bit (counter high) counter, 20 MHz frequency, and X1, X2, and X4 count modes. With only phase A and phase B signals, two channels are supported; with phase A, phase B, and index Z signals, 1 channel is supported. Each input can be debounced from 500 ns to 25.5 ms (total of 16 selections) to eliminate extraneous noise or switch induced transients. Encoder input signals must be within -5 V to +10 V and the switching threshold is TTL (1.3V).

Quadrature encoders generally have three outputs: A, B, and Z. The A and B signals are pulse trains driven by an optical sensor inside the encoder. As the encoder shaft rotates, a laminated optical shield rotates inside the encoder. The shield has three concentric circular patterns of alternating opaque and transparent windows through which an LED shines. There is one LED and one phototransistor for each of the concentric circular patterns. One phototransistor produces the A signal, another phototransistor produces the B signal and the last phototransistor produces the Z signal. The concentric pattern for A has 512 window pairs (or 1024, 4096, etc.)

When using a counter for a trigger source, use a pre-trigger with a value of at least 1. Since all counters start at zero with the initial scan, there is no valid reference in regard to rising or falling edge. Setting a pre-trigger to 1 or more ensures that a valid reference value is present, and that the first trigger is legitimate.

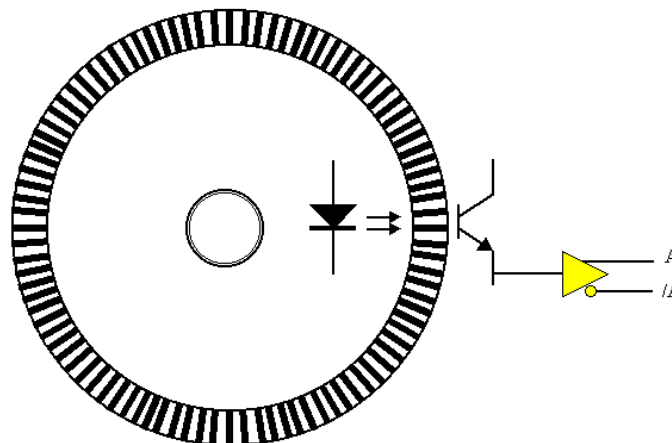

The concentric pattern for B has the same number of window pairs as A—except that the entire pattern is rotated by 1/4 of a window-pair. Thus the B signal is always 90 degrees out of phase from the A signal. The A and B signals pulse 512 times (or 1024, 4096, etc.) per complete rotation of the encoder.

The concentric pattern for the Z signal has only one transparent window and therefore pulses only once per complete rotation. Representative signals are shown in the following figure.

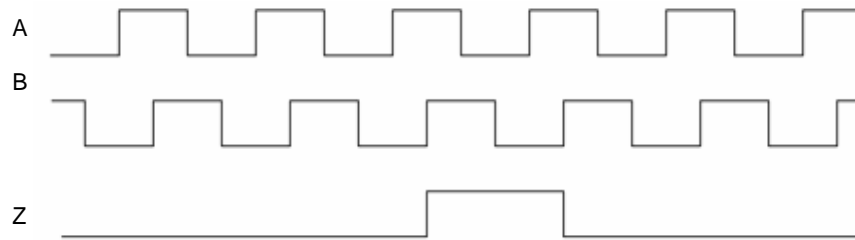

Figure 19. Representation of quadrature encoder outputs: A, B, and Z

As the encoder rotates, the A (or B) signal indicates the distance the encoder has traveled. The frequency of A (or B) indicates the velocity of rotation of the encoder. If the Z signal is used to zero a counter (that is clocked by A) then that counter gives the number of pulses the encoder has rotated from its reference. The Z signal is a reference marker for the encoder. It should be noted that when the encoder is rotating clockwise (as viewed from the back), A will lead B and when the encoder is rotating counterclockwise, A lags behind B. If the counter direction control logic is such that the counter counts upward when A leads B and counts downward when A lags B, then the counter gives direction control as well as distance from the reference.

Maximizing encoder accuracy

If there are 512 pulses on A, then the encoder position is accurate to within $360^\circ/512$.

You can get even greater accuracy by counting not only rising edges on A but also falling edges on A, giving position accuracy to 360 degrees/ 1024 .

You get maximum accuracy counting rising and falling edges on A and on B (since B also has 512 pulses.) This gives a position accuracy of $360^\circ/2048$. These different modes are known as X1, X2, and X4.

Connecting the USB-2533 to an encoder

You can use up to two encoders with each USB-2533 in your acquisition system. Each A and B signal can be made as a single-ended connection with respect to common ground.

Differential applications are not supported. For single-ended applications:

- Connect signals A, B, and Z to the counter inputs on the USB-2533.
- Connect each encoder ground to GND.

You can also connect external pull-up resistors to the USB-2533 counter input terminal blocks by placing a pull-up resistor between any input channel and the encoder power supply. Choose a pull-up resistor value based on the encoder's output drive capability and the input impedance of the USB-2533. Lower values of pull-up resistors cause less distortion, but also cause the encoder's output driver to pull down with more current.

Connecting external pull-up resistors

For open-collector outputs, you can connect external pull-up resistors to the counter input terminal blocks. You can place a pull-up resistor between any input channel and the provided +5 V power supply.

Choose a pull-up resistor value based on the encoder's output drive capability and the input impedance of the board. Lower values of pull-up resistors cause less distortion but also cause the encoder's output driver to pull down with more current.

Wiring to one encoder: Figure 20 shows the connections for one encoder to a module.

The following figure illustrates connections for one encoder to a 68-pin SCSI connector on a USB-2533. The "A" signal must be connected to an even-numbered channel and the associated "B" signal must be connected to the next [higher] odd-numbered channel. For example, if "A" were connected to CTR0, "B" would be connected to CTR1.

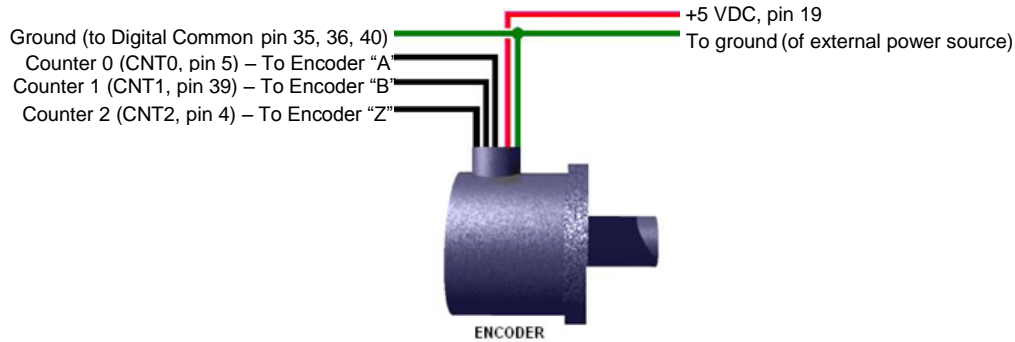

Figure 20. Encoder connections to pins on the SCSI connector*

* Connections can instead be made to the associated screw-terminals of a connected TB-100 connector.

The "A" signal must be connected to an even-numbered channel and the associated "B" signal must be connected to the next higher odd-numbered channel. For example, if "A" were connected to counter 0, then "B" would be connected to counter 1.

If the encoder stops rotating, but is vibrating (due to it being mounted to a machine), you can use the debounce feature to eliminate false edges. Choose an appropriate debounce time and apply it to each encoder channel. Refer to [Debounce modes](#) on page 28 for additional information regarding debounce times.

You can get the relative position and velocity from the encoder. However, during an acquisition, you cannot get data that is relative to the Z-position until the encoder locates the Z-reference.

Note that the number of Z-reference crossings can be tabulated. If the encoder was turning in only one direction, then the Z-reference crossings equal the number of complete revolutions. This means that the data streaming to the PC is *relative position*, $period = 1/velocity$, and *revolutions*.

A typical acquisition might take six readings off of the USB-2533 as illustrated below. The user determines the scan rate and the number of scans to take.

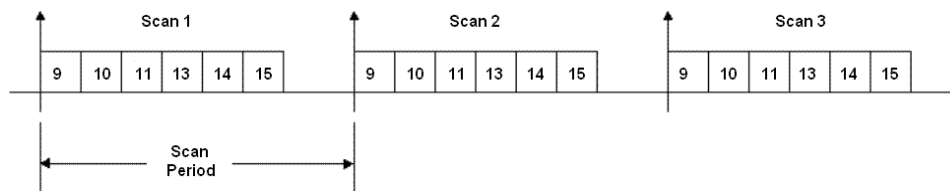

Figure 21. USB-2533 acquisition of six readings per scan

Digital channels do not take up analog channel scan time.

In general, the output of each channel's counter is latched at the beginning of each scan period (called the *start-of-scan*.) Every time the USB-2533 receives a *start-of-scan* signal, the counter values are latched and are available to the USB-2533.

The USB-2533 clears all counter channels at the beginning of the acquisition. This means that the values returned during scan period 1 are always zero. The values returned during scan period 2 reflect what happened during scan period 1.

The scan period defines the timing resolution for the USB-2533. If you need a higher timing resolution, shorten the scan period.

Wiring for two encoders: Figure 22 shows the single-ended connections for two encoders. Differential connections do not apply.

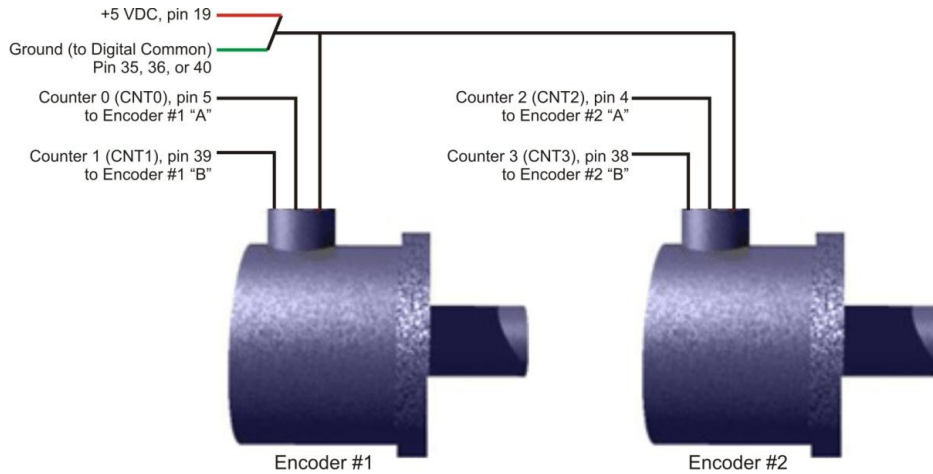

Figure 22. Two encoders connected to pins on the SCSI connector*

* Connections can instead be made to the associated screw-terminals of a connected TB-100 connector.

Each signal (A, B) can be connected as a single-ended connection with respect to the common digital ground (GND). Both encoders can draw their power from the +5 V power output (pin 19) on the 68-pin SCSI connector.

Connect each encoder's power input to +5 V power. Connect the return to digital common (GND) on the same connector. Make sure that the current output spec is not violated. With the encoders connected in this manner, there is no relative positioning information available on encoder #1 or #2 since there is no Z signal connection for either. Therefore only distance traveled and velocity can be measured for each encoder.

Timer outputs

Two 16-bit timer outputs are built into the USB-2533. Each timer is capable of generating a different square wave with a programmable frequency in the range of 16 Hz to 1 MHz.

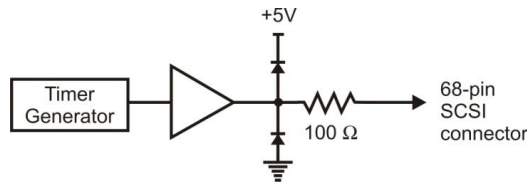

Figure 23. Typical USB-2533 timer channel

Example: Timer outputs

Timer outputs are programmable square waves. The period of the square wave can be as short as 1 μ s or as long as 65535 μ s. Refer to the table below for examples of timer output frequencies.

Timer output frequency examples

Divisor	Timer output frequency
1	1 MHz
100	10 kHz
1000	1 kHz
10000	100 Hz
65535	15.259 Hz

The two timer outputs can generate different square waves. The timer outputs can be updated asynchronously at any time.

Using detection setpoints for output control

What are detection setpoints?

With the USB-2533's setpoint configuration feature, you can configure up to 16 detection setpoints associated with channels in a scan group. Each setpoint can update the following, allowing for real-time control based on acquisition data:

- FIRSTPORTC digital output port with a data byte and mask byte
- timers

Setpoint configuration overview

You can program each detection setpoint as one of the following:

- Single point referenced – Above, below, or equal to the defined setpoint.
- Window (dual point) referenced – Inside or outside the window.
- Window (dual point) referenced, hysteresis mode – Outside the window high forces one output (designated Output 2; outside the window low-forces another output, designated as Output 1).

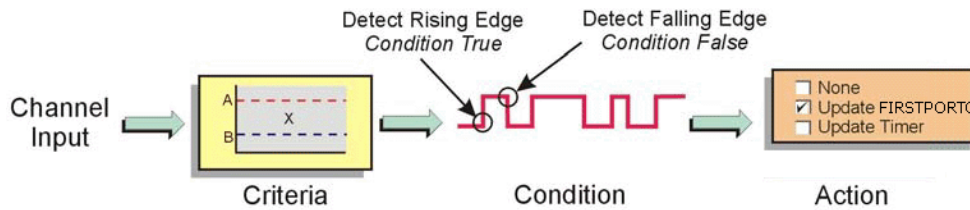

A digital detect signal is used to indicate when a signal condition is *True* or *False*—for example, whether or not the signal has met the defined criteria. The detect signals can be part of the scan group and can be measured as any other input channel, thus allowing real time data analysis during an acquisition.

The detection module looks at the 16-bit data being returned on a channel and generates another signal for each channel with a setpoint applied (*Detect1* for Channel 1, *Detect2* for Channel 2, and so on). These signals serve as data markers for each channel's data. It does not matter whether that data is volts, counts, or timing.

A channel's detect signal shows a rising edge and is *True* (1) when the channel's data meets the setpoint criteria. The detect signal shows a falling edge and is *False* (0) when the channel's data does not meet the setpoint criteria. The *True* and *False* states for each setpoint criteria are explained in the "Using the setpoint status register" section on page 37.

Criteria – input signal is equal to X		Action - driven by condition
Compare X to:	Setpoint definition (choose one)	Update conditions:
Limit A or Limit B	<ul style="list-style-type: none"> ▪ Equal to A ($X = A$) ▪ Below A ($X < A$) ▪ Above B ($X > B$) 	<i>True</i> only: <ul style="list-style-type: none"> ▪ If <i>True</i>, then output value 1 ▪ If <i>False</i>, then perform no action <i>True and False</i> : <ul style="list-style-type: none"> ▪ If <i>True</i>, then output value 1 ▪ If <i>False</i>, then output value 2
Window* (non-hysteresis mode)	<ul style="list-style-type: none"> ▪ Inside ($B < X < A$) ▪ Outside: $B > X$; or, $X > A$ 	<i>True</i> only <ul style="list-style-type: none"> ▪ If <i>True</i>, then output value 1 ▪ If <i>False</i>, then perform no action <i>True and False</i> <ul style="list-style-type: none"> ▪ If <i>True</i>, then output value 1 ▪ If <i>False</i>, then output value 2

Criteria – input signal is equal to X		Action - driven by condition
Window* (hysteresis mode)	<ul style="list-style-type: none"> ■ Above A ($X > A$) ■ Below ($X < B$) (Both conditions are checked when in hysteresis mode) 	Hysteresis mode (forced update) <ul style="list-style-type: none"> ■ If $X > A$ is True, then output value 2 until $X < B$ is True, then output value 1. ■ If $X < B$ is True, then output value 1 until $X > A$ is True, then output value 2. This is saying: <ul style="list-style-type: none"> (a) If the input signal is outside the window high, then output value 2 until the signal goes outside the window low, and (b) if the signal is outside the window low, then output value 1 until the signal goes outside the window high. There is no change to the detect signal while within the window.

The detect signal has the timing resolution of the scan period as seen in the diagram below. The detect signal can change no faster than the scan frequency ($1/\text{scan period}$.)

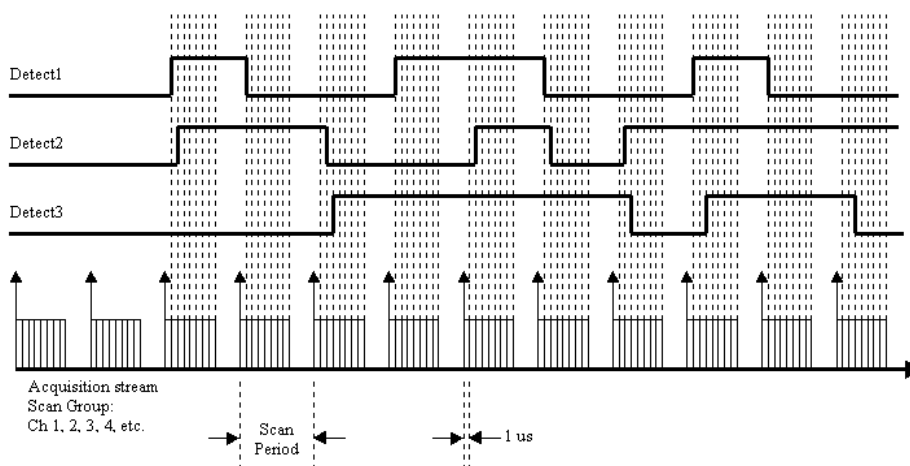

Figure 24. Example diagram of detection signals for channels 1, 2, and 3

Each channel in the scan group can have one detection setpoint. There can be no more than 16 total setpoints total applied to channels within a scan group.

Detection setpoints act on 16-bit data only. Since the USB-2533 has 32-bit counters, data is returned 16-bits at a time. The lower word, the higher word, or both lower and higher words can be part of the scan group. Each counter input channel can have one detection setpoint for the counter's lower 16-bit value and one detection setpoint for the counter's higher 16-bit value.

Setpoint configuration

You program all setpoints as part of the pre-acquisition setup, similar to setting up an external trigger. Since each setpoint acts on 16-bit data, each has two 16-bit compare values: a high limit (*limit A*) and a low limit (*limit B*). These limits define the setpoint window.

There are several possible conditions (criteria) and effectively three update modes, as explained in the following configuration summary.

Set high limit

You can set the 16-bit high limit (*limit A*) when configuring the USB-2533 through software.

Set low limit

You can set the 16-bit low limit (*limit B*) when configuring the USB-2533 through software.

Set criteria

- Inside window: Signal is below 16-bit high limit and above 16-bit low limit.
- Outside window: Signal is above 16-bit high limit, or below 16-bit low limit.
- Greater than value: Signal is above 16-bit low limit, so 16-bit high limit is not used.
- Less than value: Signal is below 16-bit high limit, so 16-bit low limit is not used.
- Equal to value: Signal is equal to 16-bit high limit, and limit B is not used.

The equal to mode is intended for use when the counter or digital input channels are the source channel.

You should only use the *equal to* 16-bit high limit (*limit A*) mode with counter or digital input channels as the channel source. If you want similar functionality for analog channels, then use the *inside window* mode

- Hysteresis mode: Outside the window, high forces output 2 until an outside the window low condition exists, then output 1 is forced. Output 1 continues until an outside the window high condition exists. The cycle repeats as long as the acquisition is running in hysteresis mode.

Set output channel

- None
- Update FIRSTPORTC
- Update timerx

Update modes

- Update on *True* only
- Update on *True* and *False*

Set values for output

- FIRSTPORTC* value or timer value when input meets criteria.
- FIRSTPORTC* value or timer value when input does not meet criteria.

* By default, FIRSTPORTC comes up as a digital input. You may want to initialize FIRSTPORTC to a known state before running the input scan to detect the setpoints.

When using setpoints with triggers other than immediate, hardware analog, or TLL, the setpoint criteria evaluation begins immediately upon arming the acquisition.

Using the setpoint status register

You can use the setpoint status register to check the current state of the 16 possible setpoints. In the register, Setpoint 0 is the least-significant bit and Setpoint 15 is the most-significant bit. Each setpoint is assigned a value of 0 or 1.

- A value of 0 indicates that the setpoint criteria is not met—in other words, the condition is *False*.
- A value of 1 indicates that the criteria has been met—in other words, the condition is *True*.

In the following example, the criteria for setpoints 0, 1, and 4 is satisfied (*True*), but the criteria for the other 13 setpoints has not been met.

Setpoint #	15	14	13	12	11	10	9	8	7	6	5	4	3	2	1	0
<i>True</i> (1)	0	0	0	0	0	0	0	0	0	0	0	1	0	0	1	1
<i>False</i> (0)	<<< Most significant bit							Least significant bit >>>								

From the above table we have 10011 binary, or 19 decimal, derived as follows:

- Setpoint 0, having a *True* state, shows 1, giving us decimal 1.
- Setpoint 1, having a *True* state, shows 1, giving us decimal 2.
- Setpoint 4, having a *True* state, shows 1, giving us decimal 16.

For proper operation, the setpoint status register must be the last channel in the scan list.

Examples of control outputs

Detecting on analog input and FIRSTPORTC updates

Update mode: Update on *True* and *False*

Criteria: Channel 4: *inside window*

Channel 4 is programmed with reference to two setpoints (limit A and limit B) which define a window for that channel.

Channel	Condition	State of detect signal	Action
4	Within window (between limit A and limit B) for channel 4	True	When Channel 4's analog input voltage is within the window, update FIRSTPORTC with 70h.
		False	When the above stated condition is <i>False</i> (channel 4 analog input voltage is outside the window), update FIRSTPORTC with 30h.

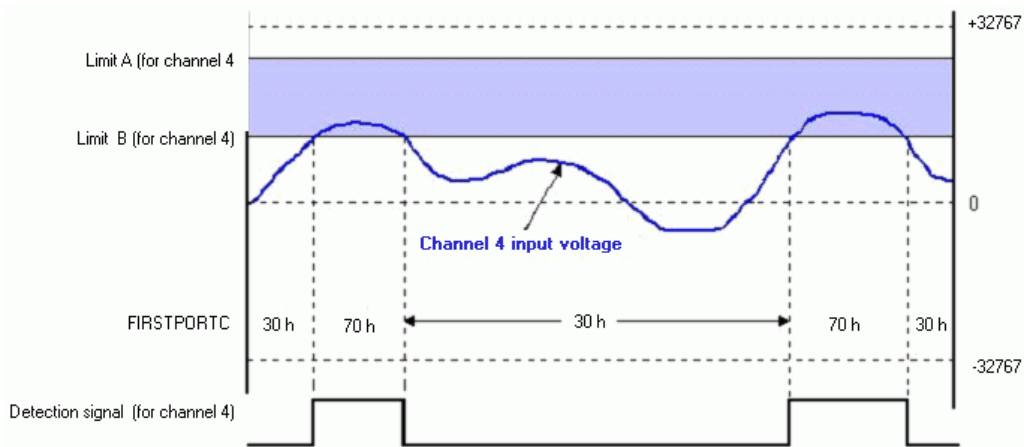

Figure 25. Analog inputs with setpoints update on *True* and *False*

You can program control outputs programmed on each setpoint, and use the detection for channel 4 to update the FIRSTPORTC digital output port with one value (70 h in the example) when the analog input voltage is within the shaded region and a different value when the analog input voltage is outside the shaded region (30 h in the example).

Detection on an analog input, timer output updates

Update Mode: Update on *True* and *False*

Criteria Used: Inside window

The figure below shows how a setpoint can be used to update a timer output. Channel 3 is an analog input channel. A setpoint is applied using *update on True and False*, with a criteria of *inside-the-window*, where the signal value is inside the window when simultaneously less than Limit A but greater than Limit B.

Whenever the channel 3 analog input voltage is inside the setpoint window (condition *True*), Timer0 is updated with one value; and whenever the channel 3 analog input voltage is outside the setpoint window (condition *False*) timer0 will be updated with a second output value.

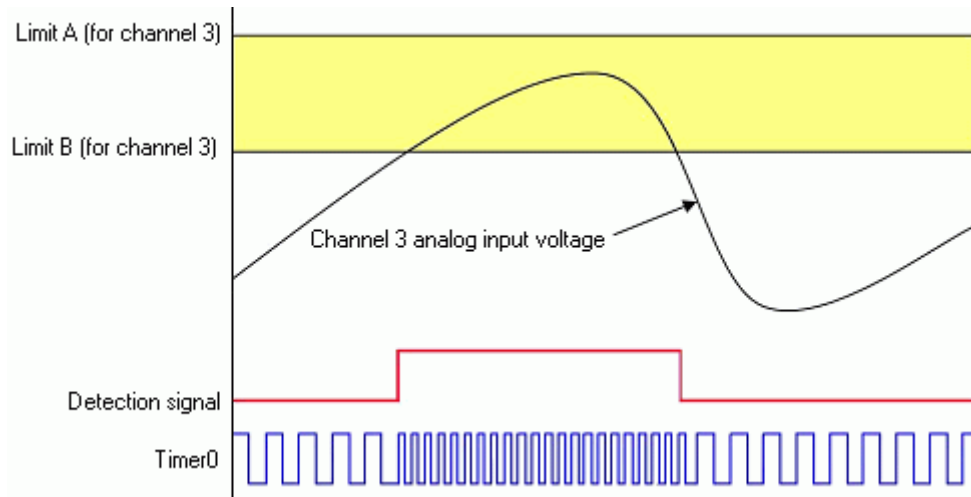

Figure 26. Timer output update on *True* and *False*

Using the hysteresis function

Update mode: N/A, the hysteresis option has a forced update built into the function

Criteria used: Window criteria for above and below the set limits

The figure below shows analog input Channel 3 with a setpoint which defines two 16-bit limits, Limit A (High) and Limit B (Low). These are being applied in the hysteresis mode and FIRSTPORTC is updated accordingly.

In this example, Channel 3's analog input voltage is being used to update FIRSTPORTC as follows:

- When outside the window, low (below limit B) FIRSTPORTC is updated with 30 h. This update remains in effect until the analog input voltage goes above Limit A.
- When outside the window, high (above limit A), FIRSTPORTC is updated with 30 h. This update remains in effect until the analog input signal falls below limit B. At that time we are again outside the limit "low" and the update process repeats itself.

Hysteresis mode can also be done with a timer output, instead of a FIRSTPORTC digital output port.

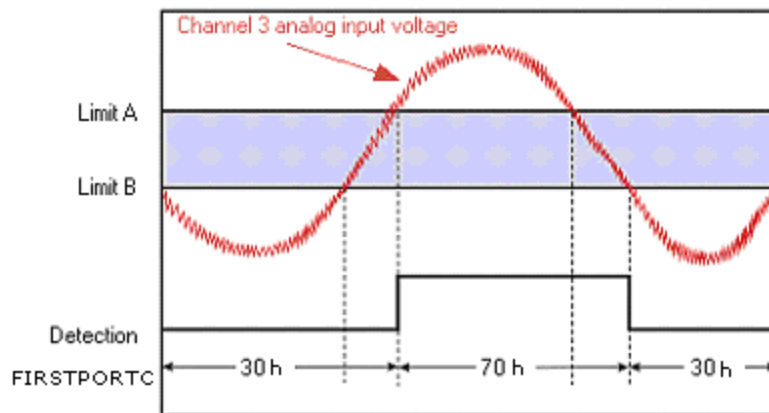

Figure 27. Channel 3 in hysteresis mode

Detecting setpoints on a totalizing counter

In the following figure, Channel 1 is a counter in totalize mode. Two setpoints define a point of change for Detect 1 as the counter counts upward. The detect output is high when inside the window (greater than Limit B (the low limit) but less than Limit A (the high limit).

In this case, the Channel 1 setpoint is defined for the 16 lower bits of channel 1's 32-bit value. The FIRSTPORTC digital output port could be updated on a *True* condition (the rising edge of the detection signal). You can also update timer outputs with a value.

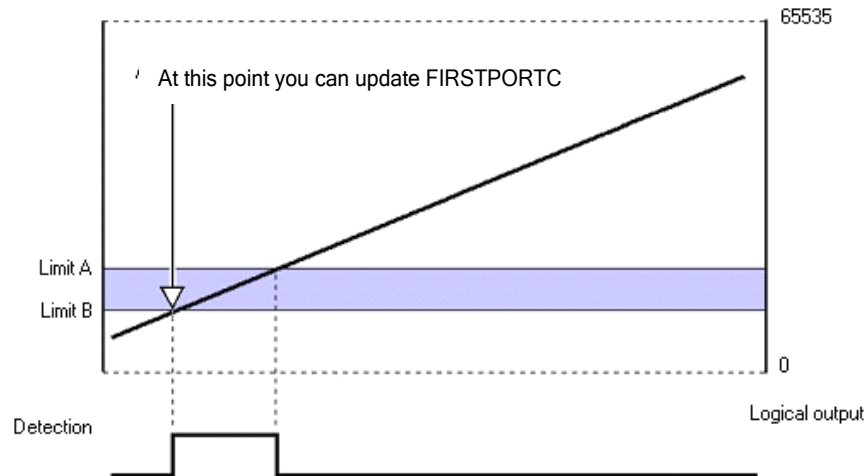

Figure 28. Channel 1 in totalizing counter mode, inside the window setpoint

Detection setpoint details

Controlling digital and timer outputs

You can program each setpoint with an 8-bit digital output byte and corresponding 8-bit mask byte. When the setpoint criteria is met, the FIRSTPORTC digital output port can be updated with the given byte and mask.

You can also program each setpoint a timer update value.

In *hysteresis mode*, each setpoint has two forced update values. Each update value can drive one timer or the FIRSTPORTC digital output port. *In hysteresis mode, the outputs do not change when the input values are inside the window.* There is one update value that gets applied when the input values are less than the window and a different update value that gets applied when the input values are greater than the window.

Update on *True* and *False* uses two update values. The update values can drive FIRSTPORTC or timer outputs.

FIRSTPORTC digital outputs can be updated immediately upon setpoint detection.

FIRSTPORTC or timer update latency

Setpoints allow timers or FIRSTPORTC digital outputs to update very quickly. Exactly how fast an output can update is determined by these factors:

- scan rate
- synchronous sampling mode
- type of output to be updated

For example, you set an acquisition to have a scan rate of 100 kHz, which means each scan period is 10 μ s. Within the scan period you sample six analog input channels. These are shown in the following figure as channels 1 through 6. The ADC conversion occurs at the beginning of each channel's 1 μ s time block.

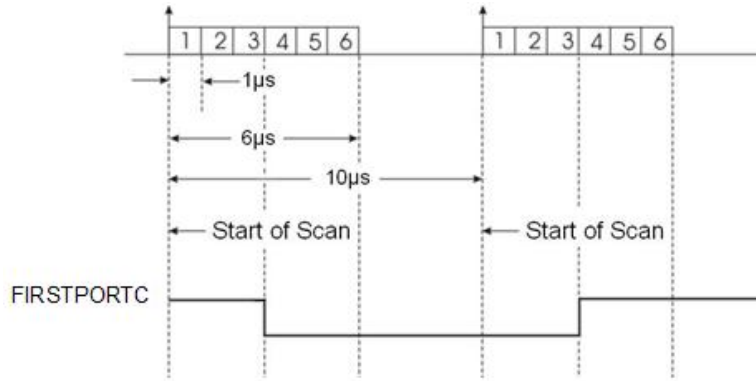

Figure 29. Example of FIRSTPORTC latency

By applying a setpoint on analog input channel 2, that setpoint gets evaluated every 10 µs with respect to the sampled data for channel 2.

Due to the pipelined architecture of the analog-to-digital converter system, the setpoint cannot be evaluated until 2 µs after the ADC conversion. In the example above, the FIRSTPORTC digital output port can be updated no sooner than 2 µs after channel 2 has been sampled, or 3 µs after the start of the scan. This 2 µs delay is due to the pipelined ADC architecture. The setpoint is evaluated 2 µs after the ADC conversion and then FIRSTPORTC can be updated immediately.

The detection circuit works on data that is put into the acquisition stream at the scan rate. This data is acquired according to the pre-acquisition setup (scan group, scan period, etc.) and returned to the PC. Counters are latched into the acquisition stream at the beginning of every scan. The actual counters may be counting much faster than the scan rate, and therefore only every 10th, 100th, or n^{th} count shows up in the acquisition data.

As a result, you can set a small detection window on a totalizing counter channel and have the detection setpoint "stepped over" since the scan period was too long. Even though the counter value stepped into and out of the detection window, the actual values going back to the PC may not. This is true no matter what mode the counter channel is in.

When setting a detection window, keep a scan period in mind. This applies to analog inputs and counter inputs. Quickly changing analog input voltages can step over a setpoint window if not sampled often enough.

There are three possible solutions for overcoming this problem:

- Shorten the scan period to give more timing resolution on the counter values or analog values.
- Widen the setpoint window by increasing limit A and/or lowering limit B.
- A combination of both solutions (1 and 2) could be made.

Mechanical drawing

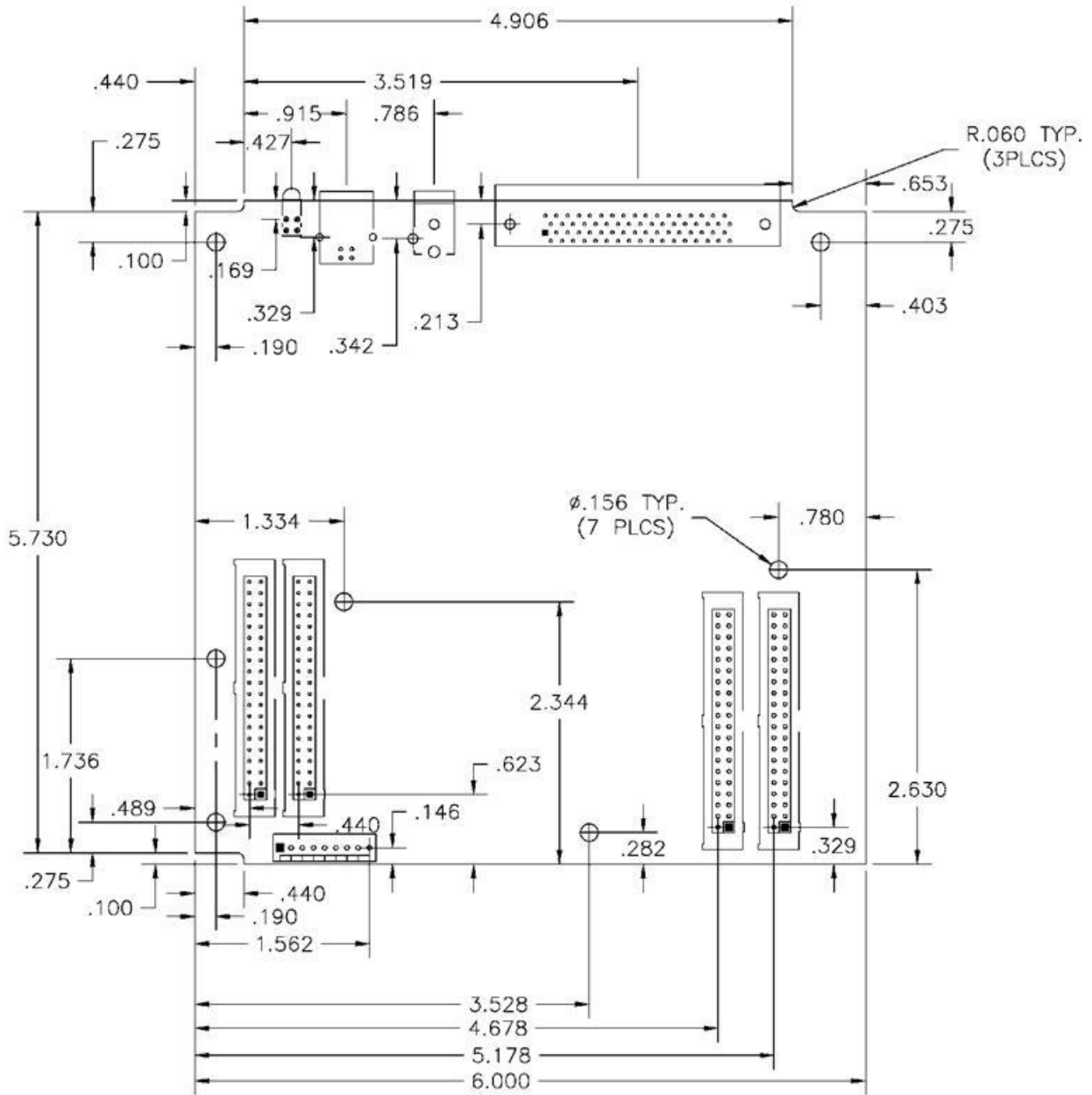

Figure 30. Circuit board dimensions

Calibrating the USB-2533

Board ranges are calibrated at the factory using a digital NIST traceable calibration method in which a correction factor for each range is stored on the unit at the time of calibration.

Two calibration tables are stored on the board in EPROM — one table contains the factory calibration, and the other is available for field calibration. You can adjust the AI calibration while the board is installed in the acquisition system without destroying the factory calibration supplied with the board.

You can perform field calibration automatically in seconds with InstaCal. No external hardware or instruments are required. Field calibration derives its traceability through an on-board reference which has a stability of 0.005% per year.

Calibrate the board after it has fully warmed up; the recommended warm-up time is 30 minutes. For best results, calibrate the board immediately before making critical measurements. The high resolution analog components on the board are somewhat sensitive to temperature. Pre-measurement calibration ensures that your board is operating at optimum calibration values.

The recommended calibration interval is one year.

Specifications

All specifications are subject to change without notice.

Typical for 25°C unless otherwise specified.

Specifications in *italic text* are guaranteed by design.

Analog input

Table 1. Analog input specifications

Parameter	Specification
A/D converter type	Successive approximation
Resolution	16-bit
Number of channels	64 single-ended/32 differential, software-selectable
Input ranges (SW programmable)	Bipolar: ± 10 V, ± 5 V, ± 2 V, ± 1 V, ± 0.5 V, ± 0.2 V, ± 0.1 V
Sample rate	1 MHz max
Nonlinearity (integral)	± 2 LSB max
Nonlinearity (differential)	± 1 LSB max
A/D pacing	Onboard input scan clock, external source (XAPCR)
Trigger sources and modes	See Table 7
Acquisition data buffer	1 MSample
Configuration memory	Programmable I/O
Maximum usable input voltage + common mode voltage (CMV + Vin)	Range ± 10 V, ± 5 V, ± 2 V, ± 1 V, ± 0.5 V: 10.5 V max Range ± 0.2 V, ± 0.1 V: 2.1 V max
<i>Signal to noise and distortion</i>	<i>72 dB typ for ± 10 V range, 1 kHz fundamental</i>
<i>Total harmonic distortion</i>	<i>-80 dB typ for ± 10 V range, 1 kHz fundamental</i>
Calibration	Auto-calibration, calibration factors for each range stored onboard in non-volatile RAM.
CMRR @ 60 Hz	-70 dB typ DC to 1 kHz
<i>Bias current</i>	<i>40 pA typ (0 °C to 35°C)</i>
<i>Crosstalk</i>	<i>-75 dB typ DC to 60 Hz; -65 dB typ @ 10 kHz</i>
<i>Input impedance</i>	<i>10 MΩ single-ended, 20 MΩ differential</i>
<i>Absolute maximum input voltage</i>	<i>± 30 V</i>

Accuracy

Table 2. Analog input accuracy specifications

Voltage range (Note 1)	Accuracy \pm (% of reading + % range) 23 °C \pm 10 °C, 1 year	Temperature coefficient \pm (ppm of reading + ppm range)/°C	Noise (cts RMS) (Note 2)
-10 V to 10 V	0.031% + 0.008%	14 + 8	2.0
-5 V to 5 V	0.031% + 0.009%	14 + 9	3.0
-2 V to 2 V	0.031% + 0.010%	14 + 10	2.0
-1 V to 1 V	0.031% + 0.02%	14 + 12	3.5
-500 mV to 500 mV	0.031% + 0.04%	14 + 18	5.5
-200 mV to 200 mV	0.036% + 0.075%	14 + 12	8.0
-100 mV to 100 mV	0.042% + 0.15%	14 + 18	14.0

Note 1: Specifications assume differential input single-channel scan, 1 MHz scan rate, unfiltered, CMV=0.0 V, 30 minute warm-up, exclusive of noise, range is +FS to -FS.

Note 2: Noise reflects 10,000 samples at 1 MHz, typical, differential short.

Thermocouples

Table 3. TC types and accuracy (Note 3)

TC type	Temperature range (°C)	Accuracy (±°C)	Noise typical (±°C)
J	-200 to + 760	1.7	0.2
K	-200 to + 1200	1.8	0.2
T	-200 to + 400	1.8	0.2
E	-270 to + 650	1.7	0.2
R	-50 to + 1768	4.8	1.5
S	-50 to + 1768	4.7	1.5
N	-270 to + 1300	2.7	0.3
B	+300 to + 1400	3.0	1.0

Note 3: Assumes 16,384 oversampling applied, CMV = 0.0 V, 60 minute warm-up, still environment, and 25 °C ambient temperature; excludes thermocouple error; TC_{in} = 0 °C for all types except B (1000 °C), PS-9V1AEPS-2500 power supply for external power.

Digital input/output

Table 4. Digital I/O specifications

Parameter	Specification
Number of I/O	24
Configuration	Three 8-bit ports; each port is programmable as input or output
Input scanning modes	Two programmable modes: <ul style="list-style-type: none"> ■ Asynchronous, under program control at any time relative to input scanning ■ Synchronous with input scanning
Input characteristics	220 Ω series resistors, 20 pF to common
Logic keeper circuit	Holds the logic value to 0 or 1 when there is no external driver
Input protection	±15 kV ESD clamp diodes parallel
<i>Input high</i>	+2.0 V to +5.0 V
<i>Input low</i>	0 to 0.8 V
<i>Output high</i>	> 2.0 V
<i>Output low</i>	< 0.8 V
Output current	Output 1.0 mA per pin, sourcing more current may require a PS-9V1AEPS-2500 power supply option
Digital input pacing	Onboard clock, external input scan clock (XAPCR)
Digital output pacing	Four programmable sources: <ul style="list-style-type: none"> ■ Onboard output scan clock, independent of input scan clock ■ Onboard input scan clock ■ External output scan clock (XDPCR), independent of external input scan clock (XAPCR) ■ External input scan clock (XAPCR)
Digital input trigger sources and modes	See Table 7
Digital output trigger sources	Start of input scan
Sampling/update rate	4 MHz max (rates up to 12 MHz are sustainable on some platforms)
Pattern generation output	Two of the 8-bit ports can be configured for 16-bit pattern generation. The pattern can also be updated synchronously with an acquisition at up to 4 MHz.

Counters

Counter inputs can be scanned based on an internal programmable timer or an external clock source.

Table 5. Counter specifications

Parameter	Specification
Channels	4 independent
Resolution	32-bit
Input frequency	20 MHz max
Input signal range	-5 V to 10 V
Input characteristics	10 k Ω pull-up, \pm 15 kV ESD protection
Trigger level	TTL
Minimum pulse width	25 ns high, 25 ns low
De-bounce times	16 selections from 500 ns to 25.5 ms, positive or negative edge sensitive, glitch detect mode or de-bounce mode
Time-base accuracy	50 ppm (0 ° to 50 °C)
Counter read pacer	Onboard input scan clock, external input scan clock (XAPCR)
Trigger sources and modes	See Table 7
Programmable mode	Counter
Counter mode options	Totalize, clear on read, rollover, stop at all Fs, 16-bit or 32-bit, any other channel can gate the counter

Input sequencer

Analog, digital, and counter inputs can be scanned based on either an internal programmable timer or an external clock source.

Table 6. Input sequencer specifications

Parameter	Specification
Input scan clock sources (Note 4)	Internal: <ul style="list-style-type: none"> ■ Analog channels from 1 μs to 1 sec in 20.83 ns steps ■ Digital channels and counters from 250 ns to 1 sec in 20.83 ns steps External. TTL level input (XAPCR): <ul style="list-style-type: none"> ■ Analog channels down to 1 μs min ■ Digital channels and counters down to 250 ns min
Programmable parameters per scan	Programmable channels (random order), programmable gain
Depth	512 locations
Onboard channel to channel scan rate	Analog: 1 MHz max Digital: 4 MHz if no analog channels are enabled, 1 MHz with analog channels enabled
External input scan clock (XAPCR) maximum rate	Analog: 1 MHz Digital: 4 MHz if no analog channels are enabled, 1 MHz with analog channels enabled
Clock signal range	Logical zero: 0 V to 0.8 V Logical one: 2.4 V to 5.0 V
Minimum pulse width	50 ns high, 50 ns low

Note 4: The maximum scan clock rate is the inverse of the minimum scan period. The minimum scan period is equal to 1 μ s times the number of analog channels.
If a scan contains only digital channels, then the minimum scan period is 250 ns. Some platforms can sustain scan rates up to 83.33 ns for digital-only scans.

Trigger sources and modes

Table 7. Trigger sources and modes

Parameter	Specification
Input scan trigger sources	<ul style="list-style-type: none"> ■ Single channel analog hardware trigger ■ Single channel analog software trigger ■ External-single channel digital trigger (TTL TRG input) ■ Digital Pattern Trigger ■ Counter/Totalizer Trigger
Input scan triggering modes	<ul style="list-style-type: none"> ■ Single channel analog hardware trigger: The first analog input channel in the scan is the analog trigger channel Input signal range: -10 V to +10 V max Trigger level: Programmable (12-bit resolution) Latency: 350 ns typ Accuracy: $\pm 0.5\%$ of reading, ± 2 mV offset max Noise: 2 mV RMS typ ■ Single channel analog software trigger: The first analog input channel in the scan is the analog trigger channel Input signal range: Anywhere within range of the trigger channel Trigger level: Programmable (16-bit resolution) Latency: One scan period (max) ■ External-single channel digital trigger (TTL trigger input): Input signal range: -15 V to +15 V max Trigger level: TTL level sensitive Minimum pulse width: 50 ns high, 50 ns low Latency: One scan period max ■ Digital pattern triggering 8-bit or 16-bit pattern triggering on any of the digital ports. Programmable for trigger on equal, not equal, above, or below a value. Individual bits can be masked for "don't care" condition. Latency: One scan period max ■ Counter/totalizer triggering Counter/totalizer inputs can trigger an acquisition. User can select to trigger on a frequency or on total counts that are equal, not equal, above, or below a value, or within/outside of a window rising/falling edge. Latency: One scan period max

Frequency/pulse generators

Table 8. Frequency/pulse generator specifications

Parameter	Specification
Channels	2 × 16-bit
Output waveform	Square wave
Output rate	1 MHz base rate divided by 1 to 65,535 (programmable)
High-level output voltage	2.0 V min @ -1.0 mA, 2.9 V min @ -400 μ A
Low-level output voltage	0.4 V max @ 400 μ A

Power consumption

Table 9. Power consumption specifications (Note 5)

Parameter	Specification
Power consumption (per board)	2400 mW

External power

Table 10. External power specifications (Note 5)

Parameter	Specification
Connector	Switchcraft # RAPC-712
Power range	6 VDC to 16 VDC; use when the USB port supplies insufficient power, or when an independent power supply is desired.
Over-voltage	20 V for 10 seconds, max

Note 5: An optional power supply (MCC p/n PS-9V1AEPS-2500) is required if the USB port cannot supply adequate power. USB 2.0 ports are required by USB 2.0 standards to supply 2500 mW (nominal at 5 V, 500 mA).

USB specifications

Table 11. USB specifications

Parameter	Specification
USB-device type	USB 2.0 high-speed mode (480 Mbps) if available (recommended), otherwise, USB 1.1 full-speed mode (12 Mbps)
Device compatibility	USB 2.0 (recommended) or USB 1.1

Environmental

Table 12. Environmental specifications

Parameter	Specification
Operating temperature range	-30 °C to +70 °C
Storage temperature range	-40 °C to +80 °C
Relative humidity	0 to 95% non-condensing

Mechanical

Table 13. Mechanical specifications

Parameter	Specification
Vibration	MIL STD 810E cat 1 and 10
Dimensions (W × D)	152.4 × 150.62 mm (6.0 × 5.93 in.)
Weight	147 g (0.32 lb)

Signal I/O connectors

Table 14. Signal connector specifications

Parameter	Specification
Connector type	68-pin standard "SCSI TYPE III" female connector (P5) 40-pin headers (J5, J6, J7, J8), AMP# 2-103328-0
Temperature measurement connector	4-channel TC screw-terminal block (TB7); Phoenix # MPT 0.5/9-2.54
Compatible cables (SCSI connector)	CA-68-3R — 68-pin ribbon cable; 3 feet CA-68-3S — 68-pin shielded round cable; 3 feet CA-68-6S — 68-pin shielded round cable; 6 feet
Compatible cables (header connectors)	C40FF-#
Compatible accessory products (SCSI connector)	<ul style="list-style-type: none"> ■ TB-100; termination board with screw terminals ■ RM-TB-100; 19-inch rack mount kit for the TB-100

Parameter	Specification
Compatible accessory products (header connectors)	CIO-MINI40

68-pin SCSI connector (P5)

Table 15. Connector P5 single-ended pinout

Pin	Function	Pin	Function
68	ACH0	34	ACH8
67	AGND	33	ACH1
66	ACH9	32	AGND
65	ACH2	31	ACH10
64	AGND	30	ACH3
63	ACH11	29	AGND
62	SGND (low level sense - not for general use)	28	ACH4
61	ACH12	27	AGND
60	ACH5	26	ACH13
59	AGND	25	ACH6
58	ACH14	24	AGND
57	ACH7	23	ACH15
56	NC	22	NC
55	NC	21	NC
54	NEGREF (reserved for self-calibration)	20	POSREF (reserved for self-calibration)
53	GND	19	+5 V (see Note 6)
52	A1	18	A0
51	A3	17	A2
50	A5	16	A4
49	A7	15	A6
48	B1	14	B0
47	B3	13	B2
46	B5	12	B4
45	B7	11	B6
44	C1	10	C0
43	C3	9	C2
42	C5	8	C4
41	C7	7	C6
40	GND	6	TTL TRG
39	CNT1	5	CNT0
38	CNT3	4	CNT2
37	TMR1	3	TMR0
36	GND	2	XAPCR (input scan clock)
35	GND	1	XDPCR (output scan clock)

Table 16. Connector P5 differential pinout

Pin	Function	Pin	Function
68	ACH0 HI	34	ACH0 LO
67	AGND	33	ACH1 HI
66	ACH1 LO	32	AGND
65	ACH2 HI	31	ACH2 LO
64	AGND	30	ACH3 HI
63	ACH3 LO	29	AGND
62	SGND (low level sense - not for general use)	28	ACH4 HI
61	ACH4 LO	27	AGND
60	ACH5 HI	26	ACH5 LO
59	AGND	25	ACH6 HI
58	ACH6 LO	24	AGND
57	ACH7 HI	23	ACH7 LO
56	NC	22	NC
55	NC	21	NC
54	NEGREF (reserved for self-calibration)	20	POSREF (reserved for self-calibration)
53	GND	19	+5 V (see Note 6)
52	A1	18	A0
51	A3	17	A2
50	A5	16	A4
49	A7	15	A6
48	B1	14	B0
47	B3	13	B2
46	B5	12	B4
45	B7	11	B6
44	C1	10	C0
43	C3	9	C2
42	C5	8	C4
41	C7	7	C6
40	GND	6	TTL TRG
39	CNT1	5	CNT0
38	CNT3	4	CNT2
37	TMR1	3	TMR0
36	GND	2	XAPCR (input scan clock)
35	GND	1	XDPCR (output scan clock)

Note 6: 5 V output, $\pm 20\%$ tolerance, 2mA USB powered, 10mA using external power.

40-pin header connectors

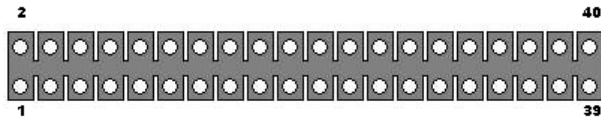

This edge of the header is closest to the center of the board. Pins 2 and 40 are labeled on the board silkscreen.

J5

Table 17. Connector J5 single-ended pinout

Pin	Function	Pin	Function
1	ACH27	2	ACH19
3	ACH26	4	ACH18
5	AGND	6	AGND
7	ACH3	8	ACH11
9	ACH2	10	ACH10
11	ACH17	12	ACH25
13	ACH16	14	ACH24
15	ACH1	16	ACH9
17	ACH0	18	ACH8
19	AGND	20	AGND
21	ACH23	22	ACH31
23	ACH22	24	ACH30
25	ACH7	26	ACH15
27	ACH6	28	ACH14
29	AGND	30	ACH21
31	ACH29	32	ACH20
33	ACH28	34	ACH5
35	ACH13	36	ACH4
37	ACH12	38	AGND
39	AGND	40	AGND

Table 18. Connector J5 differential pinout

Pin	Function	Pin	Function
1	ACH11 LO	2	ACH11 HI
3	ACH10 LO	4	ACH10 HI
5	AGND	6	AGND
7	ACH3 HI	8	ACH3 LO
9	ACH2 HI	10	ACH2 LO
11	ACH9 HI	12	ACH9 LO
13	ACH8 HI	14	ACH8 LO
15	ACH1 HI	16	ACH1 LO
17	ACH0 HI	18	ACH0 LO
19	AGND	20	AGND
21	ACH15 HI	22	ACH15 LO
23	ACH14 HI	24	ACH14 LO
25	ACH7 HI	26	ACH7 LO
27	ACH6 HI	28	ACH6 LO
29	AGND	30	ACH13 HI
31	ACH13 LO	32	ACH12 HI
33	ACH12 LO	34	ACH5 HI
35	ACH5 LO	36	ACH4 HI
37	ACH4 LO	38	AGND
39	AGND	40	AGND

J6

Table 19. Connector J6 single-ended pinout

Pin	Function	Pin	Function
1	ACH43	2	ACH59
3	ACH35	4	ACH51
5	AGND	6	ACH58
7	ACH42	8	ACH50
9	ACH34	10	ACH57
11	AGND	12	ACH49
13	ACH41	14	ACH56
15	ACH33	16	ACH48
17	ACH40	18	AGND
19	ACH32	20	ACH63
21	ACH47	22	ACH55
23	ACH39	24	AGND
25	ACH46	26	ACH62
27	ACH38	28	ACH54
29	AGND	30	ACH61
31	ACH45	32	ACH53
33	ACH37	34	ACH60
35	ACH44	36	ACH52
37	ACH36	38	AGND
39	AGND	40	AGND

Table 20. Connector J6 differential pinout

Pin	Function	Pin	Function
1	ACH19 LO	2	ACH27 LO
3	ACH19 HI	4	ACH27 HI
5	AGND	6	ACH26 LO
7	ACH18 LO	8	ACH26 HI
9	ACH18 HI	10	ACH25 LO
11	AGND	12	ACH25 HI
13	ACH17 LO	14	ACH24 LO
15	ACH17 HI	16	ACH24 HI
17	ACH16 LO	18	AGND
19	ACH16 HI	20	ACH31 LO
21	ACH23 LO	22	ACH31 HI
23	ACH23 HI	24	AGND
25	ACH22 LO	26	ACH30 LO
27	ACH22 HI	28	ACH30 HI
29	AGND	30	ACH29 LO
31	ACH21 LO	32	ACH29 HI
33	ACH21 HI	34	ACH28 LO
35	ACH20 LO	36	ACH28 HI
37	ACH20 HI	38	AGND
39	AGND	40	AGND

J7

Table 21. Connector J7 pinout

Pin	Function	Pin	Function
1	GND	2	XAPCR (input scan clock)
3	A0	4	A4
5	A1	6	A5
7	A2	8	A6
9	A3	10	A7
11	GND	12	TTL TRG
13	B0	14	B4
15	B1	16	B5
17	B2	18	B6
19	B3	20	B7
21	GND	22	+5 V (see Note 7)
23	C0	24	C4
25	C1	26	C5
27	C2	28	C6
29	C3	30	C7
31	GND	32	TMR1
33	TMR0	34	CNT1
35	CNT0	36	CNT3
37	CNT2	38	GND
39	GND	40	GND

J8

Table 22. Connector J8 pinout

Pin	Function	Pin	Function
1	+13 V (see Note 8)	2	-13 V (see Note 8)
3	NC	4	NC
5	AGND	6	AGND
7	NC	8	NC
9	NC	10	NC
11	AGND	12	AGND
13	SelfCal	14	SGND (low level sense - not for general use)
15	AGND	16	AGND
17	TTL TRG	18	XDPCR (output scan clock)
19	XAPCR (input scan clock)	20	GND (digital)
21	GND (digital)	22	GND (digital)
23	NC	24	NC
25	+5 V (see Note 7)	26	AUX PWR (output - reserved)
27	NC	28	NC
29	NC	30	NC
31	NC	32	NC
33	NC	34	NC
35	NC	36	NC
37	NC	38	NC
39	NC	40	NC

Note 7: 5 V output, $\pm 20\%$ tolerance, 2 mA USB powered, 10 mA using external power.

Note 8: ± 13 V outputs, $\pm 10\%$ tolerance, 1 mA USB powered, 5 mA using external power.

TC connector pin out (TB7)

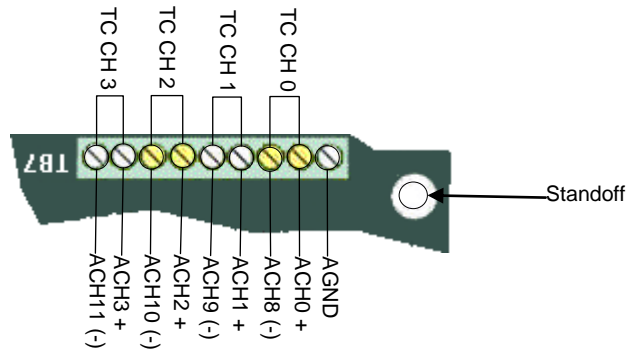

Connector TB7 pinout

Measurement Computing Corporation
10 Commerce Way
Norton, Massachusetts 02766
(508) 946-5100
Fax: (508) 946-9500
E-mail: info@mccdaq.com
www.mccdaq.com

NI Hungary Kft
H-4031 Debrecen, Hátar út 1/A, Hungary
Phone: +36 (52) 515400
Fax: +36 (52) 515414
<http://hungary.ni.com/debrecen>