

# CIO-PDIS08

Isolated Input and Relay Output

## User's Guide

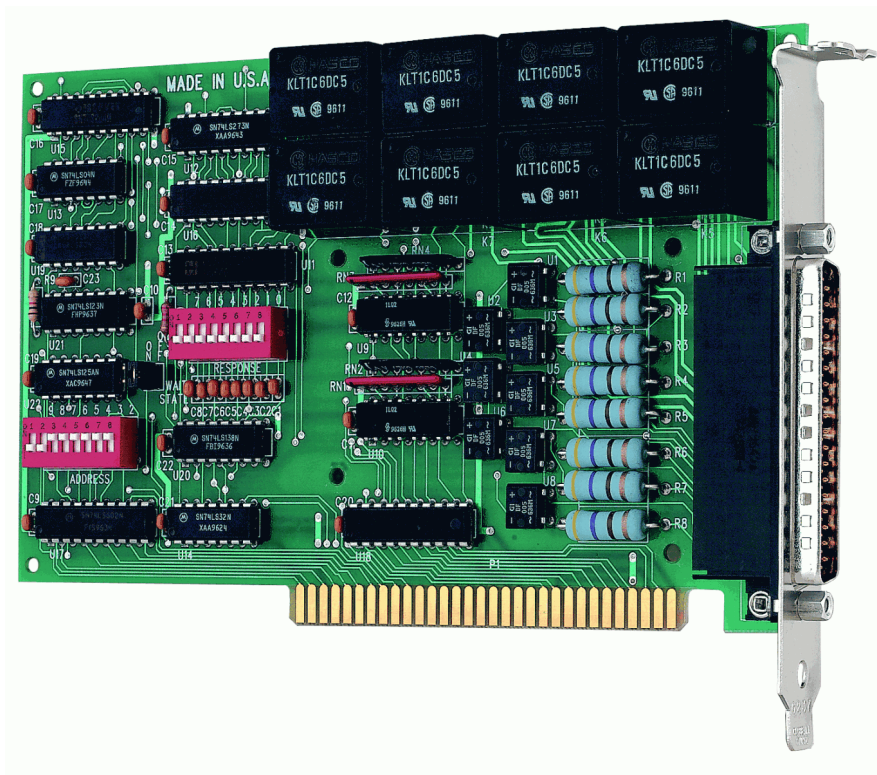

# **CIO-PDISO8**

## **Isolated Input and Relay Output**

### **User's Guide**



**MEASUREMENT  
COMPUTING™**

Document Revision 7A, March, 2010  
© Copyright 2010, Measurement Computing Corporation

## Trademark and Copyright Information

Measurement Computing Corporation, InstaCal, Universal Library, and the Measurement Computing logo are either trademarks or registered trademarks of Measurement Computing Corporation. Refer to the Copyrights & Trademarks section on [mccdaq.com/legal](http://mccdaq.com/legal) for more information about Measurement Computing trademarks. Other product and company names mentioned herein are trademarks or trade names of their respective companies.

© 2010 Measurement Computing Corporation. All rights reserved. No part of this publication may be reproduced, stored in a retrieval system, or transmitted, in any form by any means, electronic, mechanical, by photocopying, recording, or otherwise without the prior written permission of Measurement Computing Corporation.

### Notice

Measurement Computing Corporation does not authorize any Measurement Computing Corporation product for use in life support systems and/or devices without prior written consent from Measurement Computing Corporation. Life support devices/systems are devices or systems that, a) are intended for surgical implantation into the body, or b) support or sustain life and whose failure to perform can be reasonably expected to result in injury. Measurement Computing Corporation products are not designed with the components required, and are not subject to the testing required to ensure a level of reliability suitable for the treatment and diagnosis of people.



---

# Table of Contents

<b>Preface</b>	
<b>About this User's Guide .....</b>	<b>5</b>
What you will learn from this user's guide .....	5
Conventions in this user's guide .....	5
Where to find more information .....	5
<b>Chapter 1</b>	
<b>Introducing the CIO-PDISO8 .....</b>	<b>6</b>
Overview: CIO-PDISO8 features .....	6
Software features .....	6
<b>Chapter 2</b>	
<b>Installing the CIO-PDISO8 .....</b>	<b>7</b>
What comes with your CIO-PDISO8 shipment? .....	7
Hardware .....	7
Additional documentation.....	7
Optional components .....	7
Unpacking the board.....	8
Installing the software .....	8
Configuring the CIO-PDISO8 .....	8
Base address.....	9
Wait state jumper.....	10
AC input filter.....	10
Installing the CIO-PDISO8.....	10
Connecting the board for I/O operations .....	11
Connectors, cables – main I/O connector.....	11
Field wiring and signal termination accessories.....	12
<b>Chapter 3</b>	
<b>Functional Details .....</b>	<b>13</b>
Relay outputs .....	13
Form C relays .....	13
Form A relays .....	13
Isolated inputs.....	14
Extending the input range .....	14
<b>Chapter 4</b>	
<b>Specifications .....</b>	<b>15</b>
Relay specifications .....	15
Isolated inputs.....	15
Power consumption .....	15
Environmental .....	16
Main connector and pin out .....	16
<b>Declaration of Conformity .....</b>	<b>17</b>

---

## About this User's Guide

### What you will learn from this user's guide

This user's guide explains how to install, configure, and use the CIO-PDISO8 so that you get the most out of its digital input and relay output features.

This user's guide also refers you to related documents available on our web site, and to technical support resources.

### Conventions in this user's guide

**For more information on ...**

Text presented in a box signifies additional information and helpful hints related to the subject matter you are reading.

**Caution!** Shaded caution statements present information to help you avoid injuring yourself and others, damaging your hardware, or losing your data.

<#:#> Angle brackets that enclose numbers separated by a colon signify a range of numbers, such as those assigned to registers, bit settings, etc.

**bold text** **Bold** text is used for the names of objects on the screen, such as buttons, text boxes, and check boxes. For example:

1. Insert the disk or CD and click the **OK** button.

*italic text* *Italic* text is used for the names of manuals and help topic titles, and to emphasize a word or phrase. For example:

- *The software installation procedure is explained in the Quick Start Guide.*
- Never touch the exposed pins or circuit connections on the board.

### Where to find more information

For additional information relevant to the operation of your hardware, refer to the *Documents* subdirectory where you installed the MCC DAQ software (C:\Program Files\Measurement Computing\DAQ by default), or search for your device on our website at [www.mccdaq.com](http://www.mccdaq.com).

---

# Introducing the CIO-PDISO8

## Overview: CIO-PDISO8 features

The CIO-PDISO8 is an eight channel-isolated high voltage digital input and eight relay output interface board. You can use the CIO-PDISO8 for control and sensing applications where high voltages need to be sensed or controlled.

**Caution!** High voltages are present on the CIO-PDISO8 when you have connected high voltage inputs or outputs to the CIO-PDISO8 connector. Use extreme caution! Never handle the CIO-PDISO8 when signals are connected to the board through the connector. Never remove the protective plates from the CIO-PDISO8.

The eight inputs are optically-isolated (500 V) inputs that can be read back as a single byte. The inputs are not polarity sensitive, and may be driven by either AC (50 - 1000 Hz) or DC. Each input has a switchable low-pass filter with a time constant of 5 ms (200 Hz).

Outputs are from eight electromechanical relays. Five relays have FORM C connections, and three relays provide normally-open FORM A connections. The relays are controlled by writing to an 8-bit port. The relay control register can be read back from the same port.

### Signal conditioning installed

The CIO-PDISO8 is a combination digital I/O board with signal conditioning installed. Most accessory boards provide signal conditioning or easy-to-access signal termination. The CIO-PDISO8 does not require additional signal conditioning.

**Caution!** We recommend NOT using screw terminal boards with the CIO-PDISO8. The CIO-PDISO8 is intended to sense and control high voltages. If you use a screw terminal board, you will expose yourself and others to those high voltage signals. We recommend that you construct a safe cable to carry your signals directly from your equipment to the CIO-PDISO8 connector.

## Software features

For information on the features of *InstaCal* and the other software included with your CIO-PDISO8, refer to the *Quick Start Guide* that shipped with your device.

---

# Installing the CIO-PDISO8

## What comes with your CIO-PDISO8 shipment?

The following items are shipped with the CIO-PDISO8.

### Hardware

- CIO-PDISO8 board. The CIO-PDISO8 is shipped with a protective plate covering some components. The board is shown here without the protective plate.

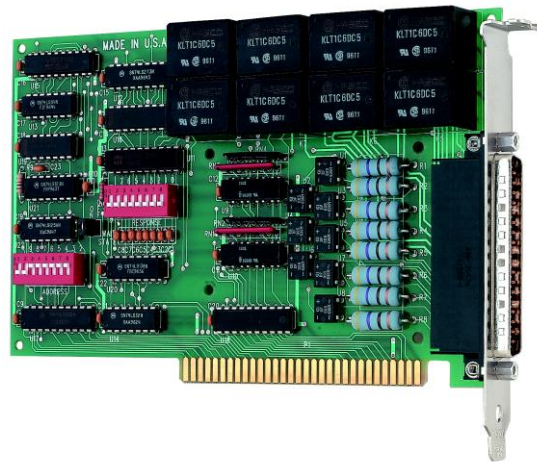

### Additional documentation

For information on the features of *InstaCal* and the other software included with your CIO-PDISO8, refer to the *Quick Start Guide* that shipped with your device. The *Quick Start Guide* is also available in PDF at [www.mccdaq.com/PDFs/manuals/DAQ-Software-Quick-Start.pdf](http://www.mccdaq.com/PDFs/manuals/DAQ-Software-Quick-Start.pdf).

Check [www.mccdaq.com/download.htm](http://www.mccdaq.com/download.htm) for the latest software version.

### Optional components

- C37FF-x cable



- Signal termination and conditioning accessories  
MCC provides signal termination products for use with the CIO-PDISO8. Refer to [Field wiring, signal termination and conditioning](#) on page 12 for a complete list of compatible accessory products.



## Unpacking the board

As with any electronic device, you should take care while handling to avoid damage from static electricity. Before removing the CIO-PDISO8 from its packaging, ground yourself using a wrist strap or by simply touching the computer chassis or other grounded object to eliminate any stored static charge.

If any components are missing or damaged, notify Measurement Computing Corporation immediately by phone, fax, or e-mail:

- Phone: 508-946-5100 and follow the instructions for reaching Tech Support.
- Fax: 508-946-9500 to the attention of Tech Support
- Email: [techsupport@mccdaq.com](mailto:techsupport@mccdaq.com)

## Installing the software

Refer to the *Quick Start Guide* for instructions on installing the software on the *Measurement Computing Data Acquisition Software CD*. This booklet is available in PDF at [www.mccdaq.com/PDFs/manuals/DAQ-Software-Quick-Start.pdf](http://www.mccdaq.com/PDFs/manuals/DAQ-Software-Quick-Start.pdf).

## Configuring the CIO-PDISO8

The CIO-PDISO8 has one base address switch, one input filter switch, and one wait state jumper which you must set before installing the board in your computer. The *InstaCal* calibration and test program included with the CIO-PDISO8 will show you how to set the switches. Run *InstaCal* before you open your computer and install the board. The CIO-PDISO8 is shipped with the factory-default settings listed below.

Factory-configured default settings

Switch/jumper	Default setting
Base address switches	300h (768 decimal)
Input Filter Select switches	
Wait State jumper	OFF position

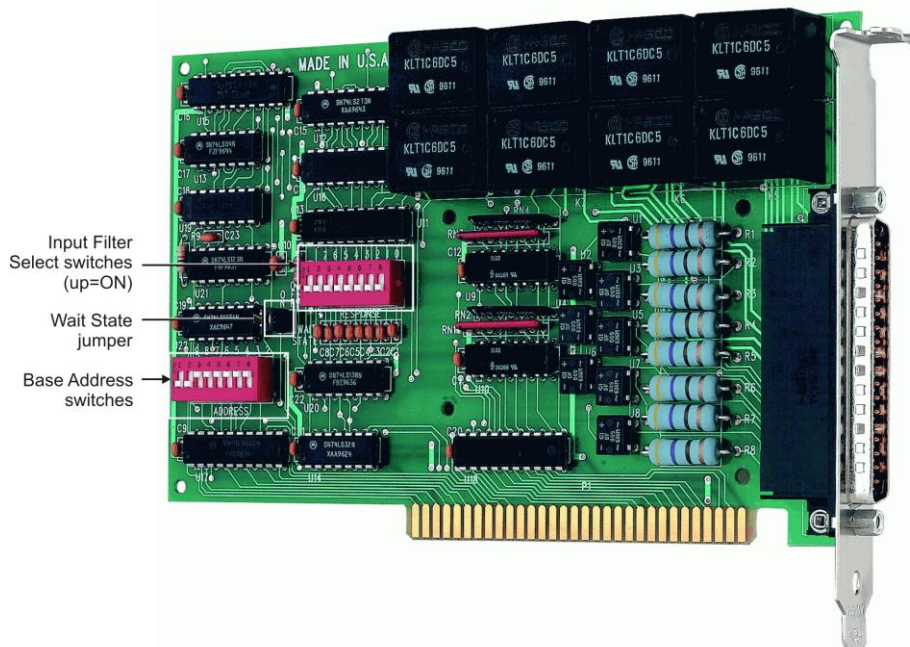

Figure 1. Switch and jumper locations

## Base address

The base address switch sets the starting I/O location where the CPU can access the registers of the CIO-PDISO8. The factory default is 300h (768 decimal).

Before you install the CIO-PDISO8 in your computer, set the base address by using the dip switch labeled **ADDRESS** located on the board. The easiest way to set the base address switch is to let *InstaCal* show you the correct settings. However, if are already familiar with setting ISA base addresses, you may use the base address switch description below to guide your base address selection.

Unless there is already another board in your system using address 300 hex (768 decimal), leave the switches as they are set at the factory. The example shown in Figure 2 shows the settings for the factory-default base address of 300 hex.

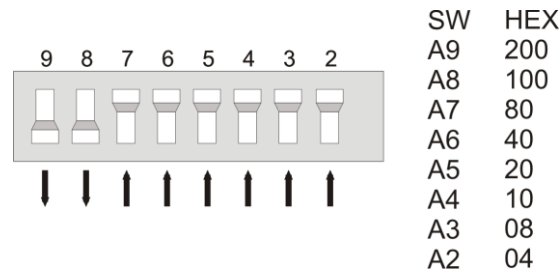

Figure 2. CIO-PDISO8 base address switches

In the default configuration shown in Figure 2, addresses 9 and 8 are DOWN, and all others are UP. Address 9 = 200 hex (512 decimal) and address 8 = 100 hex (256 decimal); when added together they equal 300 hex (768 decimal).

### Disregard the numbers printed on the switch

When setting the base address, refer to the numbers printed in white on the printed circuit board.

#### PC I/O addresses

Hex Range	Function	Hex Range	Function
000-00F	8237 DMA #1	2C0-2CF	EGA
020-021	8259 PIC#1	2D0-2DF	EGA
040-043	8253 Timer	2E0-2E7	GPIB (AT)
060-063	8255 PPI (XT)	2E8-2EF	Serial Port
060-064	8742 Controller (AT)	2F8-2FF	Serial Port
070-071	CMOS RAM & NMI mask (AT)	300-30F	Prototype card
080-08F	DMA page registers	310-31F	Prototype card
0A0-0A1	8259 PIC #2 (AT)	320-32F	Hard disk (XT)
0A0-0AF	NMI mask (XT)	378-37F	Parallel printer
0C0-0DF	8237 #2 (AT)	380-38F	SDLC
0F0-0FF	80287 numeric CO-P (AT)	3A0-3AF	SDLC
1F0-1FF	Hard disk (AT)	3B0-3BB	MDA
200-20F	Game control	3BC-3BB	Parallel printer
210-21F	Expansion unit (XT)	3C0-3CF	EGA
238-23B	Bus mouse	3D0-3DF	CGA
23C-23F	ALT bus mouse	3E8-3EF	Serial port
270-27F	Parallel printer	3F0-3F7	Floppy disk
2B0-2BF	EGA	3F8-3FF	Serial port

## Wait state jumper

The CIO-PDISO8 board has a wait state jumper which you can set to enable an on-board wait state generator. A wait state is an extra delay injected into the processor's clock via the bus. This delay slows down the processor when the processor addresses the CIO-PDISO8 board so that signals from slow devices (chips) will be valid.

The factory default is wait state disabled (Off). You will probably never need the wait state because PC expansion slot busses are limited to 8 or 10 MHz. If you get intermittent operation, try enabling the wait state to see if that solves the problem.

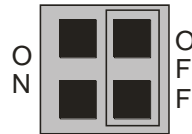

Figure 3. Wait State jumper

## AC input filter

The inputs are eight individual, optically isolated (500 V) inputs that can be read back as a single byte. The inputs are not polarity sensitive, and may be driven by either AC (50 - 1000 Hz) or DC. Each input has a switchable low-pass R-C filter having a time constant of 5 ms (200 Hz).

The switch which controls the input filters is shown in Figure 4. The filters must be used for AC inputs, and should be used for DC inputs.

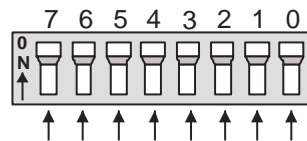

Figure 4. AC input filter switches

Unless you have reason to turn off a filter, you should enable it (switch up). With the filter on, an AC voltage within the specified frequency range present on the input produces a constant high signal to the opto-isolator.

## Installing the CIO-PDISO8

After you configure the board's switches and jumper, you can install the CIO-PDISO8 into your computer. To install your board, follow the steps below.

### Install the MCC DAQ software before you install your board

The driver needed to run your board is installed with the MCC DAQ software. Therefore, you need to install the MCC DAQ software before you install your board. Refer to the *Quick Start Guide* for instructions on installing the software.

1. Turn your computer off, open it up, and insert your board into an available ISA slot.
2. Close your computer and turn it on.
3. To test your installation and configure your board, run the *InstaCal* utility you installed in the previous section. Refer to the *Quick Start Guide* that came with your board [www.mccdaq.com/PDFs/manuals/DAQ-Software-Quick-Start.pdf](http://www.mccdaq.com/PDFs/manuals/DAQ-Software-Quick-Start.pdf) for information on how to initially set up and load *InstaCal*.

## Connecting the board for I/O operations

### Connectors, cables – main I/O connector

The table below lists the board connectors, applicable cables and compatible accessory boards.

Board connectors, cables, accessory equipment

I/O connector type	37-pin D connector
Compatible cables	C37FF-x, where x = length in feet C37FFS-x, where x =5 or 10 feet
Compatible accessory products (with the C37FFS-x and C37FF-x cables)	CIO-MINI37 SCB-37

### Information on signal connections

General information regarding signal connection and configuration is available in the *Guide to Signal Connections*.

This document is available on our web site at [www.mccdaq.com/Pdfs/DAQ-signal-connections.pdf](http://www.mccdaq.com/Pdfs/DAQ-signal-connections.pdf).

### Pin out – main I/O connector

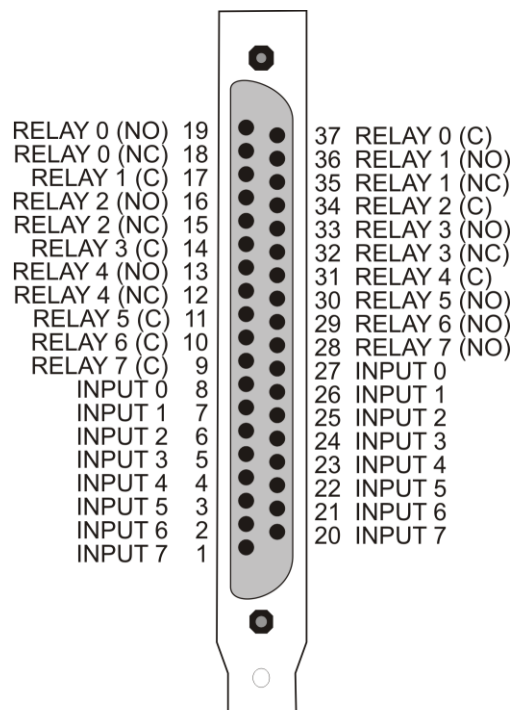

(NO) = Normally Open, (C) = Common,  
(NC) = Normally Closed.

Figure 5. Main I/O connector pin out

**Caution!** High voltages are present on the CIO-PDISO8 when you have connected high voltage inputs or outputs to the CIO-PDISO8 connector. Use extreme caution! Never handle the CIO-PDISO8 when signals are connected to the board through the connector. Never remove the protective plates from the CIO-PDISO8.

## Cabling

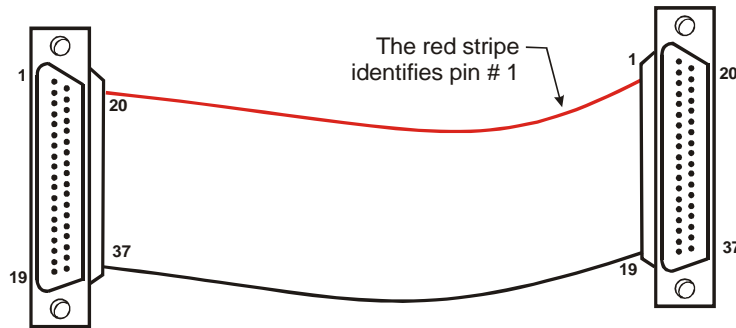

Figure 6. C37FF-x cable

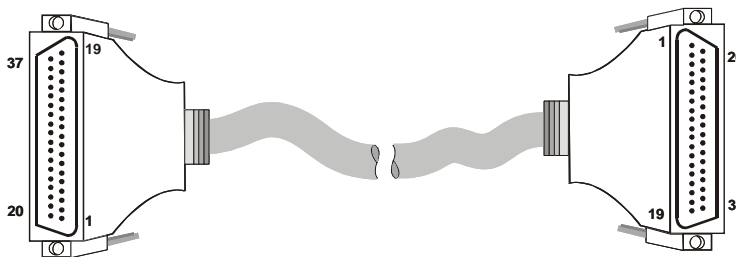

Figure 7. C37FFS-x cable

## Field wiring and signal termination accessories

You can connect the CIO-PDISO8 to the following accessory boards using the C37FF-x cable.

- CIO-MINI37 – 37-pin screw terminal board.
- SCB-37 – 37-conductor, shielded signal connection/screw terminal box.

Details on these products are available on our web site at [www.mccdaq.com/products/screw\\_terminal\\_bnc.aspx](http://www.mccdaq.com/products/screw_terminal_bnc.aspx).

**Caution!** Do not use exposed-screw terminal boards if your field voltage is more than 24 volts. Using a screw terminal board with high voltage inputs or outputs exposes you and others to those high voltage signals. Construct a safe cable to carry your signals directly from your equipment to the CIO-PDISO8 connector.

### For additional information about digital interfacing

Detailed information regarding digital interfacing is contained in MCC's *Guide to Signal Connections*. This document is available on our web site at [www.mccdaq.com/pdfs/DAQ-Signal-Connections.pdf](http://www.mccdaq.com/pdfs/DAQ-Signal-Connections.pdf).

## Functional Details

### Relay outputs

#### Form C relays

The Form C relay has a common, normally open (NO) and normally closed (NC) contact. Figure 8 shows the schematic for a Form C relay, like those connected at relay 0 through relay 4.

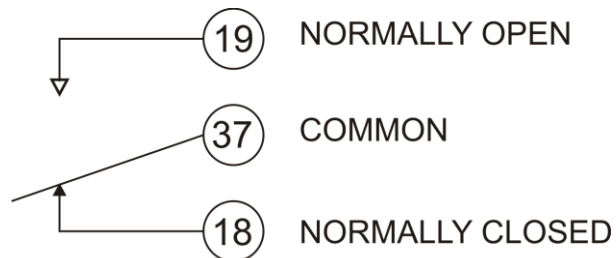

Figure 8. Form C Relay (0) contacts

- When 0 is written to the output, the common and NC are in contact.
- When 1 is written to the output, the common and NO are in contact.

#### Form A relays

The Form A relay has a common and a normally open (NO) contact. Figure 9 shows the schematic for a Form A relay, like those connected at relay 5 through relay 7.

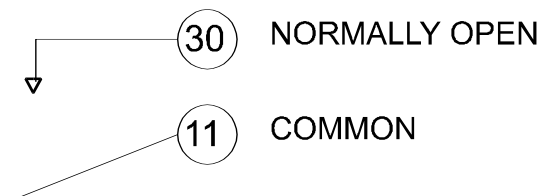

Figure 9. Form A Relay (5) contacts

- When 0 is written to the output, the common and NO are NOT in contact.
- When 1 is written to the output, the common and NO are in contact.

The Form A and Form C relays on the CIO-PDISO8 board are the same type. Only the connections to the relay poles differ.

## Isolated inputs

The C10-PDISO8 has eight isolated input channels. A schematic of a single channel is shown in Figure 10. The signals are routed through a bridge rectifier so that the inputs are not polarity sensitive.

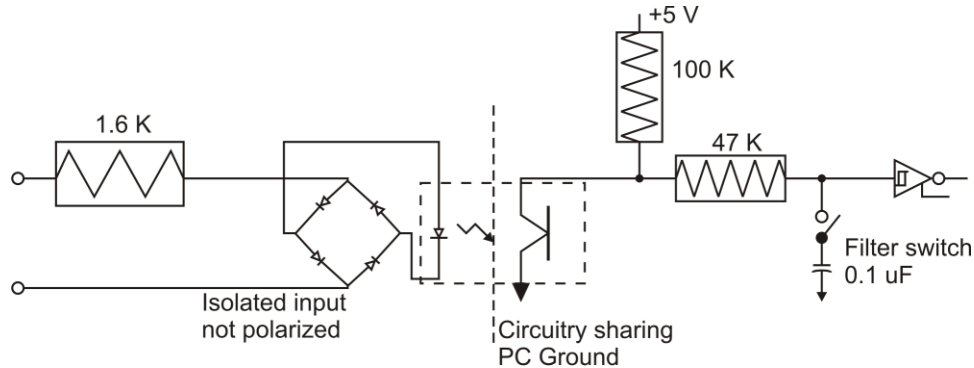
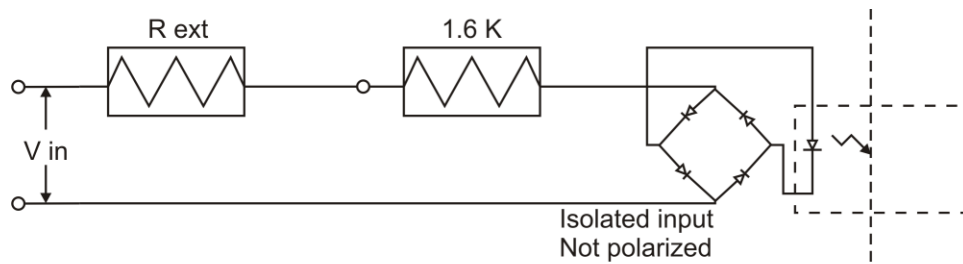

Figure 10. Isolated input schematic - simplified

## Extending the input range

To extend the input range beyond the 5-28V specified, add an external resistor. Figure 11 shows the resistor and the equations used to calculate resistor values for a given  $V_{in}$ .



$$R_{ext} = 100 * (V_{in} - 28)$$

$$P_w = R_{ext} / 10,000$$

Figure 11. Input range-extending resistor

### For more information on digital signal connections

For more information on digital signal connections and digital I/O techniques, refer to the *Guide to Signal Connections*. This document is available on our web site at [www.mccdaq.com/pdfs/DAQ-Signal-Connections.pdf](http://www.mccdaq.com/pdfs/DAQ-Signal-Connections.pdf).

## Specifications

All specifications are subject to change without notice.

Typical for 25°C unless otherwise specified.

Specifications in *italic text* are guaranteed by design.

### Relay specifications

Table 1. Relay specifications

<i>Number of relays</i>	8
<i>Contact configuration</i>	5 Form C, SPDT (Relay 0 - 4)
	3 Form A, SPST, Normally open (Relay 5 - 7)
<i>Contact rating</i>	7 A / 30 VDC or 10 A / 125 V AC
<i>Contact resistance</i>	50 milliohms
<i>Coil resistance</i>	70 ohms
<i>Isolation</i>	Between open contacts: 750 VAC, 50/60 Hz, 1 min.
	Between coil and contacts: 1500 VAC, 50/60 Hz, 1 min.
<i>Operate time</i>	10 milliseconds max.
<i>Release time</i>	5 milliseconds max.
<i>Vibration</i>	10 to 55 Hz (dual amplitude 1.5 mm)
<i>Shock</i>	10 G (11 milliseconds)
<i>Insulation resistance</i>	100 M ohms min. (500 V @ 1 minute)
<i>Life expectancy</i>	Mechanical: 10 <sup>7</sup> mechanical operations, min.
	Electrical: 100,000 min at full load

### Isolated inputs

Table 2. Isolated input specifications

<i>Number</i>	8
<i>Type</i>	Non-polarized, opto-isolated (Not TTL compatible)
<i>Voltage range</i>	DC: 5-28 V
	AC: 5-28 V (50-1000 Hz)
<i>Isolation</i>	500 V
<i>Resistance</i>	1.6 K Ohms min.
<i>Response</i>	without filter: 20 $\mu$ S
	with filter: 5 mS
<i>Filters</i>	Time constant: 5 ms (200 Hz)
	Filter control: Each input individually switch selectable

### Power consumption

Table 3. Power consumption specifications

+5 V Power	All relays off: 0.20 A typical
	All relays on: 0.70 A typical



## Environmental

Table 4. Environmental specifications

Operating temperature range	0 to 50 °C
Storage temperature range	-20 to 70 °C
Humidity	0 to 90% non-condensing

## Main connector and pin out

Table 5. Main connector specifications

Connector type	37-pin D type (male)
Dielectric strength	>1000 Vrms
Current rating	2 A
Compatible cables	C37FF-x, where x = length in feet C37FFS-x, where x = 5 or 10 feet
Compatible accessory products with the C37FF-x and C37FFS-x	CIO-MINI37 SCB-37

Table 6. Connector pin out

Pin	Signal Name	Pin	Signal Name
1	Input 7A	20	Input 7B
2	Input 6A	21	Input 6B
3	Input 5A	22	Input 5B
4	Input 4A	23	Input 4B
5	Input 3A	24	Input 3B
6	Input 2A	25	Input 2B
7	Input 1A	26	Input 1B
8	Input 0A	27	Input 0B
9	Relay 7 (C)	28	Relay 7 (NO)
10	Relay 6 (C)	29	Relay 6 (NO)
11	Relay 5 (C)	30	Relay 5 (NO)
12	Relay 4 (NC)	31	Relay 4 (C)
13	Relay 4 (NO)	32	Relay 3 (NC)
14	Relay 3 (C)	33	Relay 3 (NO)
15	Relay 2 (NC)	34	Relay 2 (C)
16	Relay 2 (NO)	35	Relay 1 (NC)
17	Relay 1 (C)	36	Relay 1 (NO)
18	Relay 0 (NC)	37	Relay 0 (C)
19	Relay 0 (NO)		

# CE Declaration of Conformity

Manufacturer: Measurement Computing Corporation  
Address: 10 Commerce Way  
Suite 1008  
Norton, MA 02766  
USA

Category: Electrical equipment for measurement, control and laboratory use.

Measurement Computing Corporation declares under sole responsibility that the product

## **CIO-PDIS08**

to which this declaration relates is in conformity with the relevant provisions of the following standards or other documents:

EU EMC Directive 89/336/EEC: Electromagnetic Compatibility, EN55022 (1987), EN50082-1

Emissions: Group 1, Class B

- EN55022 (1987): Radiated and Conducted emissions.

Immunity: EN50082-1

- IEC 801-2 (1987): Electrostatic Discharge immunity, Criteria A.
- IEC 801-3 (1984): Radiated Electromagnetic Field immunity Criteria A.
- IEC 801-4 (1988): Electric Fast Transient Burst immunity Criteria A.

Declaration of Conformity based on tests conducted by Chomerics Test Services, Woburn, MA 01801, USA in November, 1995. Test records are outlined in Chomerics Test Report #EMI0168A.95.

We hereby declare that the equipment specified conforms to the above Directives and Standards.



Carl Haapaoja, Director of Quality Assurance

**Measurement Computing Corporation**  
**10 Commerce Way**  
**Suite 1008**  
**Norton, Massachusetts 02766**  
**(508) 946-5100**  
**Fax: (508) 946-9500**  
**E-mail: [info@mccdaq.com](mailto:info@mccdaq.com)**  
**[www.mccdaq.com](http://www.mccdaq.com)**