

	Material: 1/16IN FR4	Eclipse Z7 Mainboard PCBA			
	Solder Mask Color: black	DPN: 210-393			
	DIMENSIONS IN mm	SIZE A	DATE 12/9/2019	DWG NO.	REV A4
	Author: EJC	SCALE	DIGILENT, INC.	SHEET	1/5

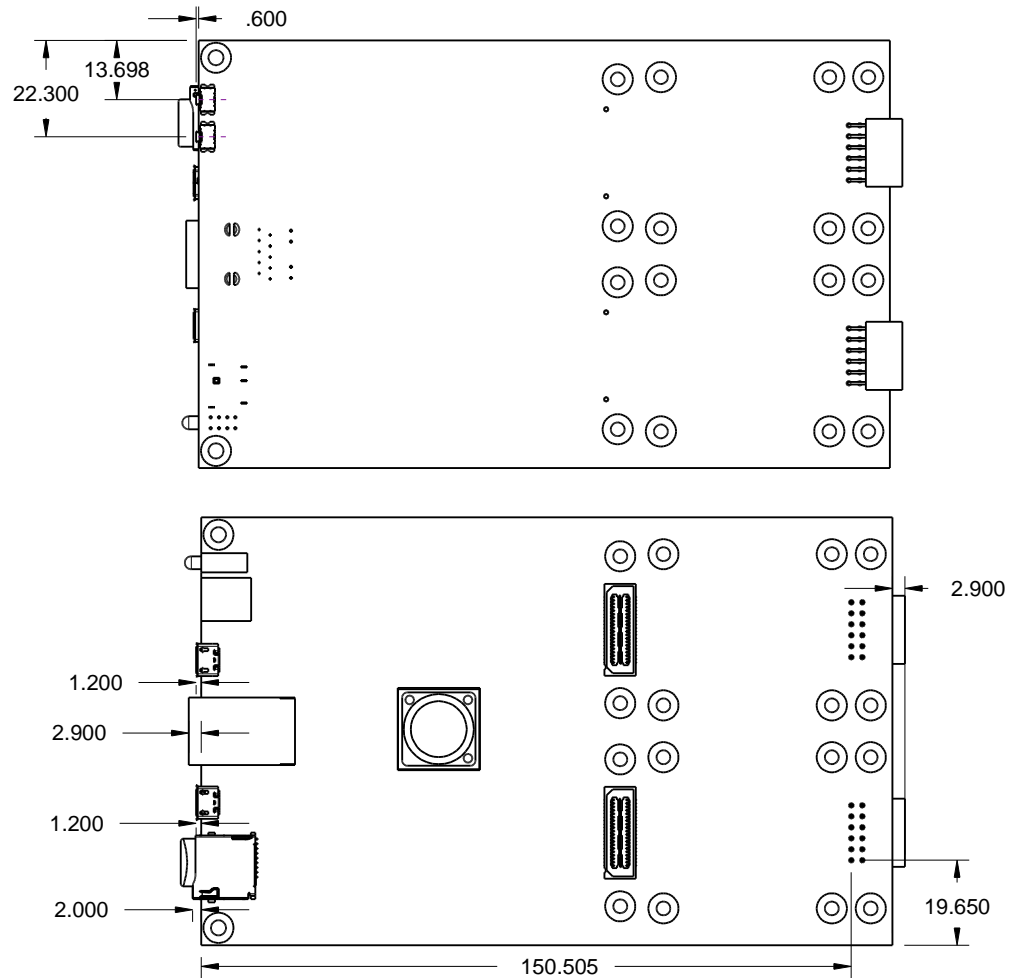

	Material: 1/16IN FR4	Eclipse Z7 Mainboard PCBA			
	Solder Mask Color: black	DPN: 210-393			
	DIMENSIONS IN mm	SIZE A	DATE 12/9/2019	DWG NO.	REV A4
	Author: EJC	SCALE	DIGILENT, INC.	SHEET	2/5

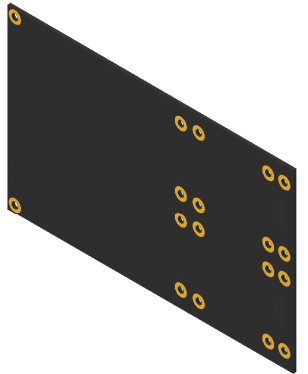
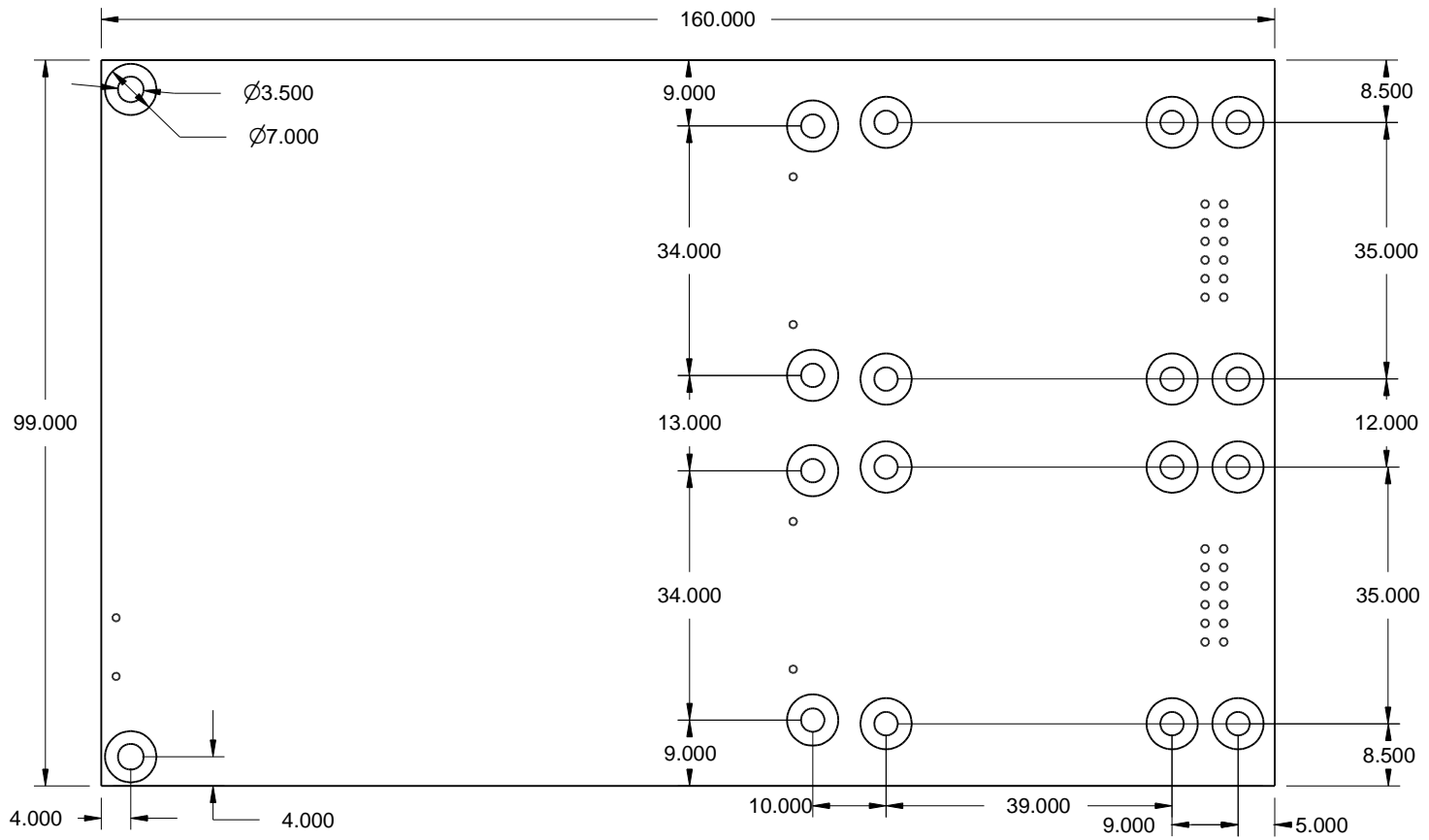

		Eclipse Z7 Mainboard PCB		
		DPN: 200-393		
DIMENSIONS IN mm		SIZE A	DATE 12/9/2019	DWG NO.
Author: EJC		SCALE		REV A4
		DIGILENT, INC.		SHEET 3/5



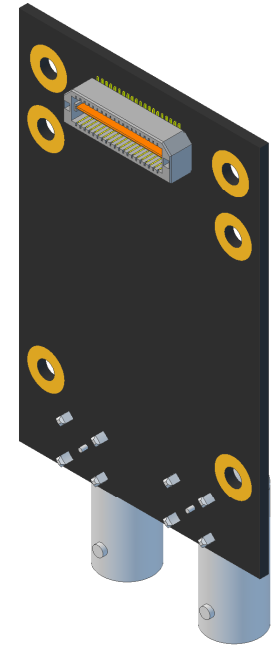
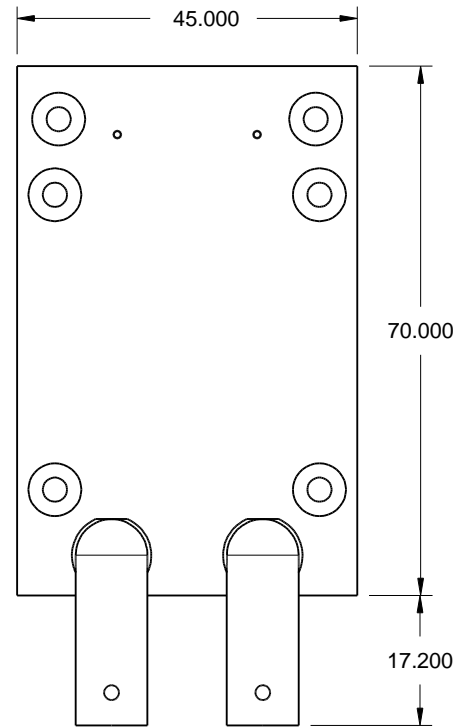
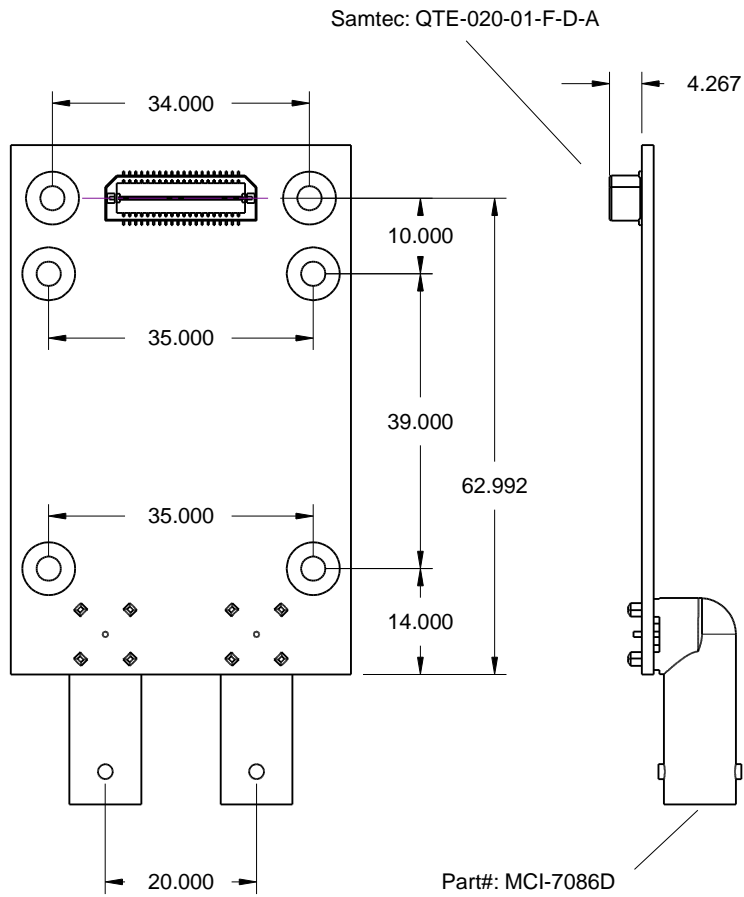

	Material: 1/16IN FR4		Eclipse Z7 BNC-POD PCBA		
	Solder Mask Color: black				
	DIMENSIONS IN mm		SIZE A	DATE 12/9/2019	DWG NO.
	Author: EJC		SCALE	DIGILENT, INC.	SHEET 4/5

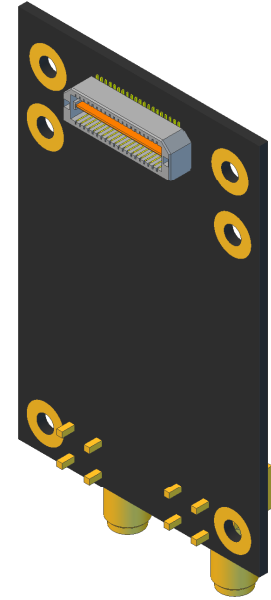
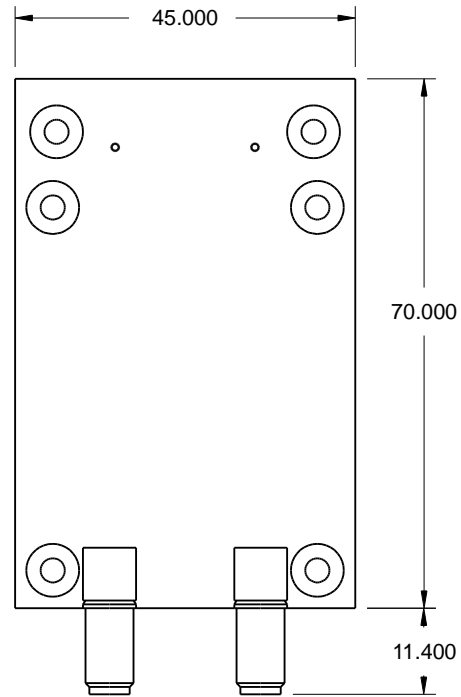
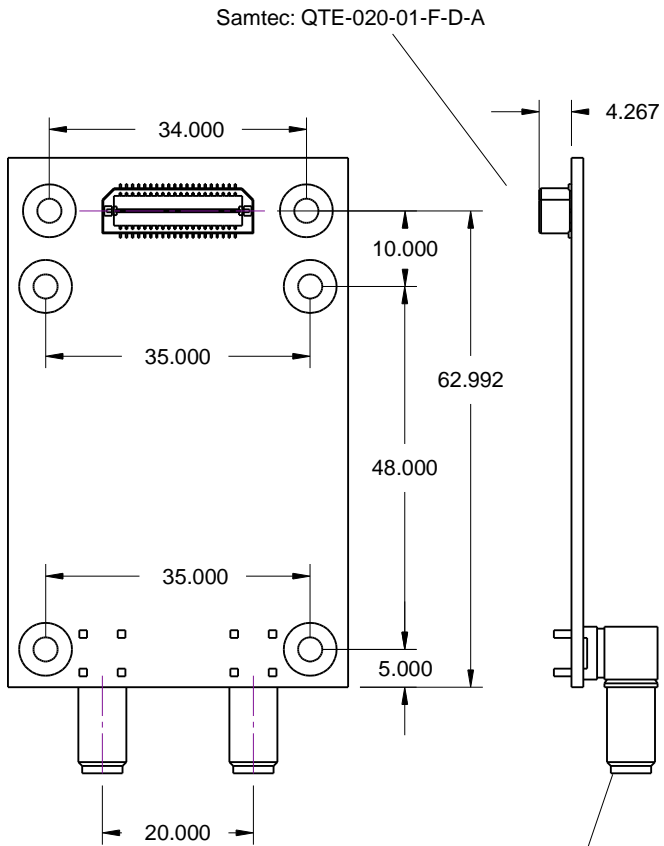

	Material: 1/16IN FR4		Eclipse Z7 SMA-POD PCBA		
	Solder Mask Color: black				
	DIMENSIONS IN mm		SIZE A	DATE 12/9/2019	DWG NO.
	Author: EJC		SCALE	DIGILENT, INC.	SHEET 5/5