

USB-2600 Series

16-Bit, 1 MS/s, High-Speed Data Acquisition

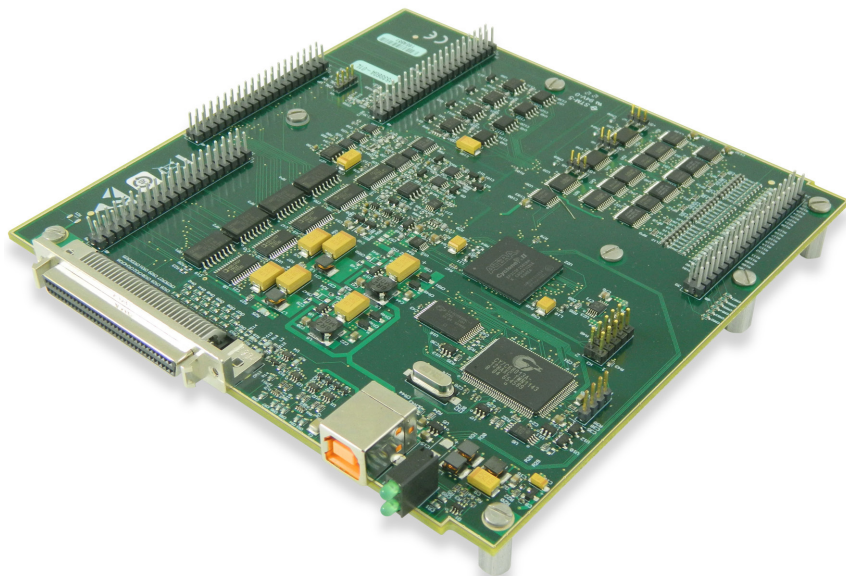

USB-2600 Series boards are designed for OEM and embedded applications.

Features

- 16-bit resolution
- 1 MS/s sample rate
- Up to 64 single-ended analog inputs
- Up to four 16-bit, 1 MS/s analog outputs
- 24 digital I/O lines
- Four 32-bit event counters
- Four timer outputs
- USB powered (no external power required)
- Includes USB cable and standoffs
- Small footprint for OEM and embedded applications

Supported Operating Systems

- Windows® 10/8/7/Vista®XP 32/64-bit
- Linux®
- Android™

Overview

The USB-2600 Series offers high-speed, multifunction data acquisition in a low-cost, board-only design. Each board offers voltage input, digital trigger input, counter input, timer output, digital I/O, and clock input.

Analog output is also available on the USB-2627 and USB-2637.

Analog Input

Each USB-2600 Series board has a 16-bit, 1 MS/s ADC coupled with 16 SE analog inputs (USB-2623 and USB-2627), 64 SE analog inputs (USB-2633 and USB-2637). The input range is fixed at ± 10 V.

Analog Output (USB-2627/USB-2637)

The four 16-bit, 1 MS/s analog output channels have an output range of ± 10 V.

The maximum rate at which analog outputs update depends on several factors, including the speed of the USB port. Typically, with the A/D operating at the full 1 MS/s rate, each analog output updates continuously from computer memory at 1 MS/s regardless of the number of channels in a scan.

Digital I/O

The 24 TTL-level digital I/O lines are software selectable for input or output. The typical maximum transfer rate (system paced, asynchronous) is 4,000 8-bit port or single-bit reads/writes per second.

Pull-Up/Down Configuration

Each board has an onboard jumper for configuring the digital I/O lines for pull-up or pull-down (default).

Trigger Input

An external digital trigger input is software selectable for edge sensitive or level sensitive mode.

Counter Input

Four 32-bit counters are included in USB-2600 Series devices. Each counter accepts frequency inputs up to 20 MHz.

Timer Output

Four pulse width modulation (PWM) timer outputs can generate a square wave with a programmable frequency in the range of 0.015 Hz to 32 MHz.

External Clock I/O

One external clock input is provided for pacing analog inputs. The USB-2627 and USB-2637 also have an external clock input for pacing analog outputs.

USB-2600 Series Selection Chart

Model	Analog Inputs	Sample Rate	Analog Outputs	Digital I/O	Counters	Timer Outputs
USB-2623	16 SE (16-bit)	1 MS/s max	0	24	4	4
USB-2627	16 SE (16-bit)	1 MS/s max	4	24	4	4
USB-2633	64 SE (16-bit)	1 MS/s max	0	24	4	4
USB-2637	64 SE (16-bit)	1 MS/s max	4	24	4	4

USB-2600 Series



Features

Calibration

The USB-2600 Series is factory-calibrated using a NIST-traceable calibration process. Specifications are guaranteed for one year.

The USB-2600 Series also supports field calibration for users to calibrate the device locally with the InstaCal utility.

Signal Connections

All signals are available from the 68-pin SCSI connectors or the four header connectors. The headers also provide two additional timer outputs, and an additional 48 SE analog inputs on the USB-2633 and USB-2637. Use a C40FF-x or custom cable for header connections.

TB-100 Screw Terminal Board

The optional TB-100 screw terminal board connects directly to the SCSI connector using a CA-68-xx ribbon cable. The TB-100 provides access to 16 SE analog inputs, up to four analog outputs, 24 digital I/O, and all counters/timers. When using the TB-100 with the USB-2633 and USB-2637, access to the remaining 48 SE analog inputs is available through the 40-pin header connectors.

TB-103 Screw Terminal Board

The optional TB-103 screw terminal board connects directly to the 40-pin headers on a USB-2600 Series board, and secures to the board with the included stand-offs. The TB-103 provides access for up to 64 SE analog inputs (when using a USB-2633 or USB-2637), up to 4 analog outputs (when using a USB-2627 or USB-2637), 24 digital I/O and all counters/timers.

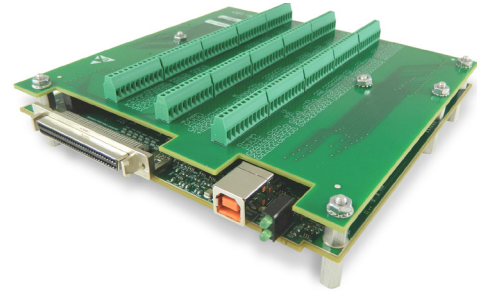

USB-2637 connected to TB-103 screw-terminal board.

USB-2600 Series Block Diagram

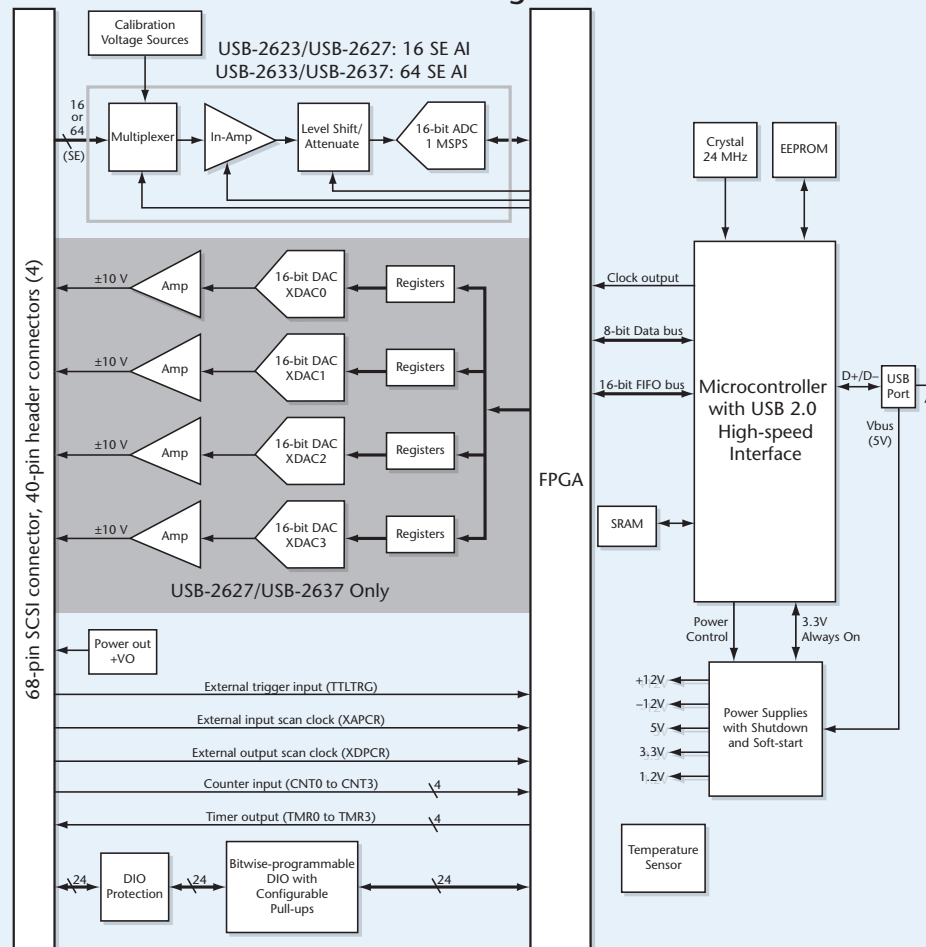







USB-2600 Series

Software

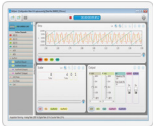
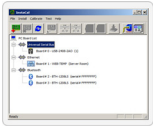

Software Support

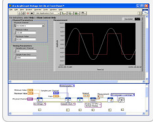
USB-2600 Series devices are supported by the software in the table below.

Ready-to-Run Applications	
DAQami™	 <p>Data acquisition companion software with drag-and-drop interface that is used to acquire, view, and log data, and generate signals. DAQami can be configured to log analog, digital, and counter channels, and to view that data in real-time or post-acquisition on user-configurable displays. Logged data can be exported for use in Excel® or MATLAB®. Windows OS</p> <p>DAQami is included with the free MCC DAQ Software bundle. Install DAQami and try the fully-functional software for 30 days. After 30 days, all features except for data logging and data export will continue to be available – data logging and data export features can be unlocked by purchasing the software.</p>
InstaCal™	 <p>An interactive installation, configuration, and test utility for MCC hardware. Windows OS</p> <p>InstaCal is included with the free MCC DAQ Software bundle.</p>
TracerDAQ™ and TracerDAQ Pro	 <p>Virtual strip chart, oscilloscope, function generator, and rate generator applications used to generate, acquire, analyze, display, and export data. Supported features may vary by hardware. The Pro version provides enhanced features. Windows OS</p> <p>TracerDAQ is included with the free MCC DAQ Software bundle.</p> <p>TracerDAQ Pro is available as a purchased software download.</p>
General-Purpose Programming Support	
Universal Library™ (UL) for Windows	 <p>Library for developing applications in C, C++, VB, C# .Net, VB .Net, and Python on Windows. The UL for Windows is included with the free MCC DAQ Software bundle. The UL Python API for Windows is available on GitHub (github.com/mccdaq/mcculw).</p>
UL for Linux®	 <p>Library for developing applications in C, C++, and Python on Linux. UL for Linux is available on GitHub (github.com/mccdaq/uldaq). Open-source, third-party Linux drivers are also available for supported MCC devices.</p>
UL for Android™	 <p>Library of Java classes for programmers who develop apps for Android-based mobile devices. UL for Android communicates with select MCC DAQ devices. Supports Android project development on Windows, Linux, Mac OS X.</p> <p>UL for Android is included with the free MCC DAQ Software bundle.</p>
Application-Specific Programming Support	
ULx for NI LabVIEW™	 <p>A comprehensive library of VIs and example programs for NI LabVIEW that is used to develop custom applications that interact with most MCC devices. Windows OS</p> <p>ULx for NI LabVIEW is included with the free MCC DAQ Software bundle.</p>
DASYLab®	 <p>Icon-based data acquisition, graphics, control, and analysis software that allows users to create complex applications in minimal time without text-based programming. Windows OS</p> <p>DASYLab is available as a purchased software download. An evaluation version is available for 28 days.</p>

USB-2600 Series

Specifications



Specifications

All specifications are subject to change without notice.
Typical for 25 °C unless otherwise specified.

Analog Input

A/D converter (ADC) type: Successive approximation; 16-bit resolution
Number of channels

USB-2623/USB-2627: 16 SE

USB-2633/USB-2637: 64 SE

Input voltage range: ± 10 V

Absolute maximum input voltage

CHx relative to AGND: ± 25 V max (power on), ± 10.5 V max (power off)

Input impedance: 1 G Ω (power on), 390 Ω (power off)

Input bias current: ± 100 pA

Input bandwidth: Small signal (-3 dB): 3.1 MHz

Input capacitance: 40 pF

Maximum working voltage: ± 10.1 V max relative to AGND

Crosstalk

Adjacent channels, DC to 10 kHz: -80 dB

Input coupling: DC

Sample rate: 0.0149 S/s to 1,000 kS/s; software selectable

Trigger source: TTLTRG

A/D pacing: Internal input scan clock, external input scan clock (XAPCR)

Burst mode: Burst rate = 1 μ s, software selectable,

Throughput

Software paced: 33 S/s to 4,000 S/s typ; system dependent

Hardware paced: 1 MS/s max

Channel queue

USB-2623/USB-2627: Up to 16 element list of random channels

USB-2633/USB-2637: Up to 64 element list of random channels

Warm-Up Time: 15 minutes min

Accuracy

Analog Input DC Voltage Measurement Accuracy

Range: ± 10 V

Gain error (% of reading): 0.031

Offset error: 915 μ V

INL error (% of Range): 0.0076

Absolute accuracy at full scale: 4775 μ V

Gain temperature coefficient (% reading/ $^{\circ}$ C): 0.0013

Offset temperature coefficient (μ V/ $^{\circ}$ C): 35

Noise Performance

For peak-to-peak noise distribution test, the input channel connects to AGND at the input terminal block, and 32,000 samples are acquired at the maximum throughput.

Range: ± 10 V

Counts: 8

LSBrms: 1.21

Settling Time for Multichannel Measurements

Range: ± 10 V

1 μ S settling accuracy (% FSR): 0.0152

5 μ S settling accuracy (% FSR): 0.0061

10 μ S settling accuracy (% FSR): 0.0015

Analog Input/Output Calibration

Recommended warm-up time: 15 minutes min

Calibration method: Self-calibration (firmware)

Calibration interval: 1 year (factory calibration)

AI calibration reference: 5 V, ± 2.5 mV max. Measured values stored in EEPROM.

Tempco: 5 ppm/ $^{\circ}$ C max

Long term stability: 15 ppm/1,000 hours

AO calibration procedure (USB-2627/USB-2637 only): Analog output pins internally routed to the analog input circuit. For best results, disconnect any XDACx connections at the I/O connectors before performing AOUT calibration.

Analog Output (USB-2627/USB-2637 Only)

Number of channels: 4; leave unused analog output channels disconnected.

Resolution: 16 bits

Output ranges (calibrated): ± 10 V

Output transient

Host computer is reset, powered on, suspended, or a reset command is issued to the device (analog outputs default to 0 V)

Duration: 100 ms

Amplitude: 2 V p-p

Powered Off

Duration: 100 ms

Amplitude: 5 V peak

Differential nonlinearity: ± 0.25 LSB typ, ± 1 LSB max

Output Current

XDACx pins: ± 3.5 mA max

Output short-circuit protection

XDACx connected to AGND: Unlimited duration

Output coupling: DC

Power on and reset state

DACs cleared to zero-scale: 0 V, ± 150 mV

Pacer source: Internal output scan clock and external output scan clock (XDPCR), independent of external input scan clock (XAPCR)

Trigger sources: TTLTRIG (refer to the "External Trigger" specifications below)

Output update rate: 1 MS/s max; not affected by the number of scan channels

Settling time to rated accuracy, 10 V step: 2 μ s

Slew rate: 20 V/ μ s

Throughput

Software paced: 33 S/s to 4,000 S/s typ, system-dependent

Hardware paced: 1 MS/s max, system-dependent

Calibrated Absolute Accuracy

Range: ± 10 V

% of reading: ± 0.0183

Offset: ± 1.831

Offset Tempco: 12.7 μ V/ $^{\circ}$ C

Gain Tempco: 13 ppm of range/ $^{\circ}$ C

Relative Accuracy (\pm LSB)

Range: ± 10 V

Relative Accuracy (INL): 4.0 typ

Digital Input/Output

Digital type: TTL

Number of I/O: 24

Configuration: Three banks of 8. Bit-configurable as input or output.

Pull-up configuration: Each port has jumper- configurable 47 k Ω resistors.

Digital I/O transfer rate (system paced, asynchronous): 33 to 4,000 port reads/writes or single bit reads/writes per second typ; system dependent.

Input high voltage: 2.0 V min, 5.0 V absolute max

Input low voltage: 0.8 V max, 0 V recommended min

Output high voltage: 4.4 V min (IOH = -50 μ A),

3.76 V min (IOH = -24 mA)

Output low voltage: 0.1 V max (IOL = 50 μ A)

0.44 V max (IOL = 24 mA)

Output current: 60 mA max, not to exceed 24 mA for one bit, resulting in 2.5 mA max when all 24 bits are enabled.

External Trigger

Trigger source: TTLTRG

Trigger mode: edge or level sensitive, rising or falling edge, high or low level

Trigger latency: 1 μ s + 1 clock cycle max

Trigger pulse width: 100 ns min

Input type: 33 Ω series resistor and 49.9 k Ω pull-down to GND

Input high voltage: 2.2 V min, 5.5 V absolute max

Input low voltage: 1.5 V max, -0.5 V absolute min, 0 V recommended min

External Clock

Terminal names: XAPCR, XDPCR

Terminal types: Input, active on rising edge

Terminal descriptions: Receives pacer clock from external source

Input clock rate: 1 MHz max

Clock pulse width: 100 ns min

Input type: 33 Ω series resistor, 47 k Ω pull-down to GND

Input high voltage: 2.2 V min, 5.5 V absolute max

Input low voltage: 1.5 V max, -0.5 V absolute min, 0 V recommended min

USB-2600 Series

Ordering



Counter

Number of channels: 4 channels
Resolution: 32-bit
Counter type: Event counter
Input type: 33 Ω series resistor, 47 k Ω pull-down to GND
Counter read/writes rates (software paced): 33 to 8,000 reads/writes per second
Input voltage: 2.2 V min high, 1.5 V max low
Input low voltage: maximum input voltage range: -5 V to +10 V max
Input frequency: 20 MHz max
High/low pulse width: 25 ns min

Power

Supply current: Quiescent current: 360 mA; includes up to 10 mA for the LED; does not include potential loading of the DIO bits, +VO pin, or XDACx outputs.
+VO output voltage range: 4.25 V to 5.25 V
+VO output current: 10 mA max

Environmental

Operating temperature range: 0 °C to 55 °C max
Storage temperature range: -40 °C to 85 °C max
Humidity: 0% to 90% non-condensing max

Mechanical

PCB dimensions (L x W): 152.4 x 150.62 mm (6.00 x 5.93 in.)

Timer Output

Number of channels: 4 channels
Timer type: PWM output with count, period, delay, and pulse width registers
Output value: Idle low with pulses high, software selectable, output invert
Internal clock frequency: 64 MHz
Register widths: 32-bit
High pulse width: 10.42 ns, min
Low pulse width: 10.42 ns, min
Output high voltage: 4.4 V min (IOH = -50 μ A)
3.76 V min (IOH = -1.0 mA)
Output low voltage: 0.1 V max (IOL = 50 μ A), 0.44 V max (IOL = 1.0 mA)
Output waveform: Square wave
Output rate: 64 MHz base rate divided by 2³²; software selectable.

Order Information

Hardware

Part No.	Description
USB-2623	USB-based DAQ device with 16 SE analog inputs, 1 MS/s throughput; 24 digital I/O lines; four 32-bit counter input channels; and four timer outputs.
USB-2627	USB-based DAQ device with 16 SE analog inputs, 1 MS/s throughput, 4 analog outputs, 24 digital I/O lines, four 32-bit counter input channels, and four timer outputs.
USB-2633	USB-based DAQ device with 64 SE analog inputs, 1 MS/s throughput; 24 digital I/O lines; four 32-bit counter input channels; and four timer outputs.
USB-2637	USB-based DAQ device with 64 SE analog inputs, 1 MS/s throughput, 4 analog outputs, 24 digital I/O lines, four 32-bit counter input channels, and four timer outputs.

Accessories & Cables

Part No.	Description
TB-100	Termination board with screw-terminals; connects via a CA-68-3R, CA-68-3S, or CA-68-6S cable
TB-103	Termination board with screw terminals; mates directly with the USB-2600 Series; includes mounting stand-offs
CIO-MINI40	40-pin universal screw-terminal board
CA-68-3R	68-conductor ribbon cable, 3 ft.
C40FF-x	40-conductor ribbon cable, female to female, available in 2 ft. to 50 ft.

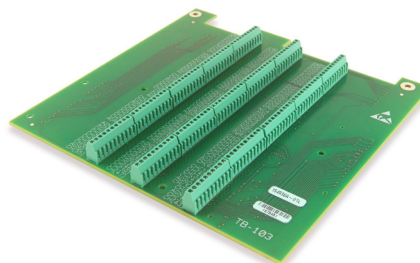

TB-103 termination board mounts directly onto a USB-2600 Series board

Software also Available from MCC

Part No.	Description
DAQami	Data acquisition companion software for acquiring data and generating signals
TracerDAQ Pro	Out-of-the-box virtual instrument suite with strip chart, oscilloscope, function generator, and rate generator – professional version
DASYLab	Icon-based data acquisition, graphics, control, and analysis software

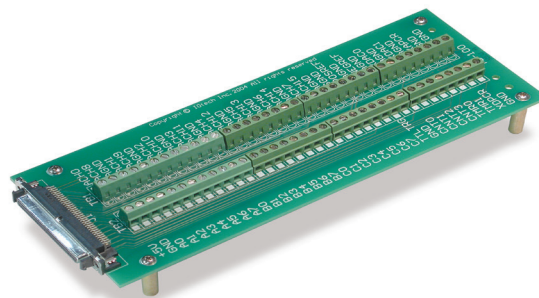

The TB-100 termination board connects to a USB-2600 Series board with a ribbon cable