

Features

- 12 thermocouple inputs
- 24-bit ADC
- ± 80 mV input range
- Simultaneous sampling
- Eight digital I/O
- Screw-terminal connectors
- Multiple trigger modes
- Ethernet interface to PC
- Expandable using multiple 6000 Series modules

Software





- Includes Encore interactive measurement software for *Out-of-the-Box* setup, acquisition, display, logging, analysis, and reporting
- Advanced feature set with no programming required
- Drag-and-drop functionality
- Easy-to-use set-up wizards
- Ability to drag data directly to Excel®
- Included data analysis tools
- Playback mode
- Sophisticated test report capability
- Incorporate multiple 6000 Series devices into one application
- Supported Windows® Operating Systems: Windows 7 (32-bit or 64-bit), Windows Vista (32-bit or 64-bit), Windows XP SP2 (32-bit), Windows 2000 SP4

Overview

The 6222 is a 12-channel thermocouple input module. It features 24-bit ADCs for highly accurate temperature measurements. The 6222 is part of the 6000 Series of instrument class, Ethernet-based data acquisition modules. Modules include powerful and easy-to-use Encore Interactive Measurement Software. Encore couples ease-of-use with advanced functionality including custom data displays, powerful analysis, and detailed reporting capabilities. 6000 Series modules feature integrated signal conditioning and a modular design that allows for system expansion. Because they use an Ethernet connection, modules can be connected directly to a PC or used in remote configurations utilizing multiple modules.



The 6222 with Encore software is a portable, thermocouple measurement solution

6000 Series Module Overview					
	6220	6222	6224	6230	6231
Feature					
Analog input type	voltage	thermocouple	strain gage/bridge	voltage	voltage
Analog inputs	12	12	12	12	12
Digital I/O	8	8	8	8	8
Resolution	16 bit	24 bit	24 bit	24 bit	24 bit
Sample rate	100 kHz per channel	2 Hz	50 kHz per channel	50 kHz per channel	50 kHz per channel
Voltage input range	± 10 V	± 80 mV	± 25 mV/V	± 10 V	± 60 V
Connector type	BNC	screw-terminal	RJ50	screw-terminal	screw-terminal
Ch-to-ch isolation	—	—	—	Yes	Yes

Analog Inputs

The 6222 is equipped with 12 thermocouple input channels. Inputs are also equipped with a ± 80 mV range. Each analog input provides 24-bit resolution with a 2 S/s sample rate per channel. All inputs are sampled simultaneously.

Digital I/O

The 6222 includes eight digital I/O lines. All eight lines are accessible via a 9-pin female DSUB connector located on the rear panel of the unit. Each digital I/O bit can be programmed individually to be either an input or an output.

Counters

There are four 32-bit counters built into each 6000 Series module. They are accessed through the 9-pin female DSUB connector located on the rear of the unit. Each counter has a maximum 20 MHz input frequency and can be used in counter or encoder (A, B, and Z) modes.

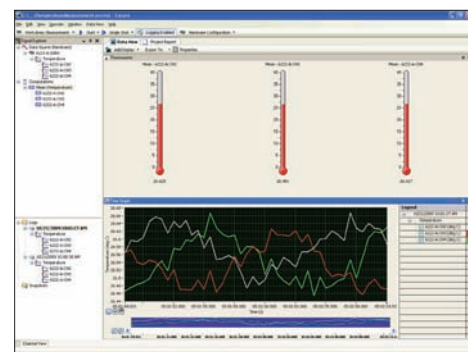

With Encore software you can display temperature and other channel data using meters, gauges, tanks and graphs

Triggering

A variety of trigger modes are supported by the 6222. A wide selection of programmable analog and digital trigger modes are available for starting an acquisition. All trigger modes, along with the number of scans and the sample rate for pre- and post-trigger data, are software programmable prior to the start of a scan sequence.

6222

General Information

6222 System Examples

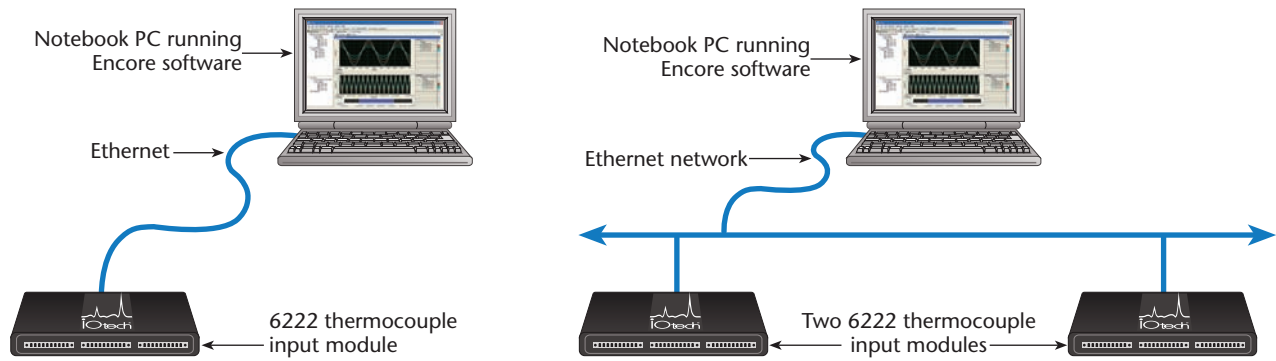

System Power Connection

The 6222 and other 6000 Series modules offer the flexibility to be powered either directly from a 19 V to 30 VDC source, or via the included TR-60U AC power adapter.

Ethernet Features

The 6000 Series transfers acquired data to the PC via 10/100BaseT Ethernet, allowing a continuous stream of data to be collected and stored in a PC's memory or hard drive. The most common and highest-performance connection is with dedicated, point-to-point Ethernet link between the PC and the 6222. With an enterprise-wide Ethernet network connection, any number of 6000 Series modules can be connected to the network.

Multi-Unit Synchronization

Multiple 6000 Series modules can be synchronized via the rear-panel SYNC ports on each unit. After connecting each module to an Ethernet port, simply connect multiple 6000 Series modules together using SYNC cables (CA-74-1). Encore software provides the capability of setting one of the 6000 Series modules as the master and the others as slaves. The sampled data phase relationship among channels between multiple devices is dependent on the "Channel SYNC Skew" specification for each device.

6222 Block Diagram

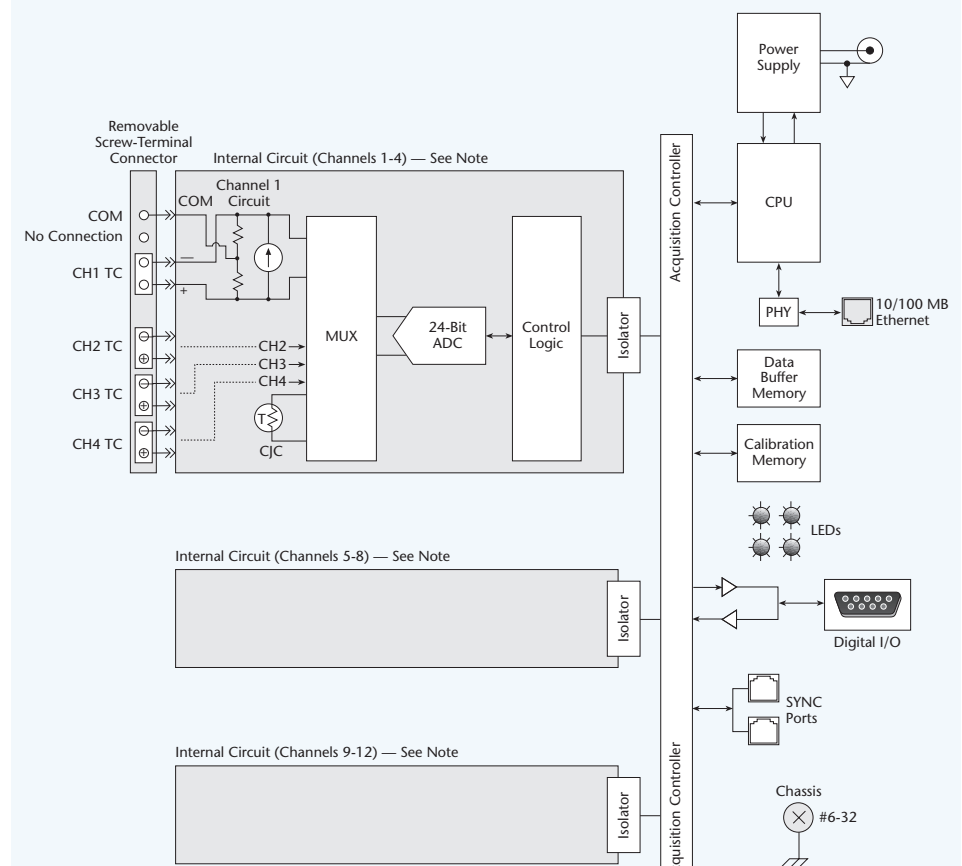

Note: Circuits for channel group 5 through 8 and group 9 through 12 look like that of the first group; for which only one channel is illustrated. Each four-channel circuit has one 24-bit ADC and one CJC.

6222

Specifications

Specifications

The following specifications are typical for the temperature range -40 to 50 °C unless otherwise noted.

Input Characteristics

Number of Channels: 12 thermocouple channels; 3 internal cold-junction compensation channels

ADC Resolution: 24 bits

Type of ADC: Delta-Sigma

Voltage Measurement Range: ±80 mV

Common-Mode Range

Channel-to-COM: ±1.5 V

Common-to-Earth Ground: ±250 V

Common-Mode Rejection Ratio (0 to 60 Hz)

Channel-to-COM: 95 dB

Common-to-Earth Ground: >170 dB

Temperature Measurement Ranges: Works over ranges defined by NIST for J, K, R, S, T, N, E, and B thermocouple types

Cold-Junction Compensation Accuracy¹

0 to 50 °C: 0.6 °C (1.1 °F) typ, 1.3 °C (2.3 °F) max

-40 to 50 °C: 1.7 °C (3.1 °F) max

Data Rate (fs): 2 S/s

Input Bandwidth (-3 dB): 15 Hz

Noise Rejection: 85 dB min at 50/60 Hz

Overvoltage Protection: ±30 V between any input and common

Differential Input Impedance: 20 MOhm

Input Current: 50 nA

Input Noise: 1 μVrms

Gain Error¹: 0.05% max at 25 °C, 0.06% typ at -40 to 50 °C, 0.1% max at -40 to 50 °C

Offset Error¹: 15 μV typ, 20 μV max

Gain Error from Source Impedance: 0.05 ppm per Ohm source impedance due to input impedance

Offset Error from Source Impedance: 0.05 μV typ, 0.07 μV max per Ohm source impedance due to input current

Power

Power Consumption: 4.1 W max

Power Jack: Barrel type, 5.5 mm O.D.; 2.1 mm I.D.

Physical Characteristics

Weight: 1.22 Kg (2.7 lb)

Dimensions: 276.9 mm W x 169.8 mm D x 30.5 mm H (10.9" W x 6.685" D x 1.2"H)

Removable Screw-Terminal Blocks: 3 blocks, 4 channels per block, 10 terminals per block

Screw-Terminal Wiring: 12 to 24 AWG wire with 10mm (0.39 in.) section of insulation stripped from connection end

Torque for Screw Terminals: 0.5 to 0.6 N • m (4.4 to 5.3 lb • in.)

Ferrules: 0.25 mm to 2.5 mm (optional, not supplied)

Digital I/O

Channels: 8 Digital I/O, programmable as a single port, or as individual lines:

Power-Up Mode: Inputs pulled low

Connector: DB-9 female (figure)

Programmable Input Scanning Modes

Asynchronous: Under program control at any time relative to analog scanning.

Synchronous: Data captured synchronously with the analog channels.

Input Levels

Low: 0 to +0.8 V

High: +2.0 V to +5.0 V

Input Voltage Range without Damage: -0.6 V to +5.6 V max

Input Pull-Down Resistor: 10 kOhm

Output Voltage Range: 0 to +3.0 V

(may be externally pulled up to 5.6 V without damage)

Output Resistance: 40 Ohm

Output Levels: (See 6000 Series Digital Output graph above)

Sampling: 1 MHz max continuous

Output Timing: Outputs are always written asynchronously

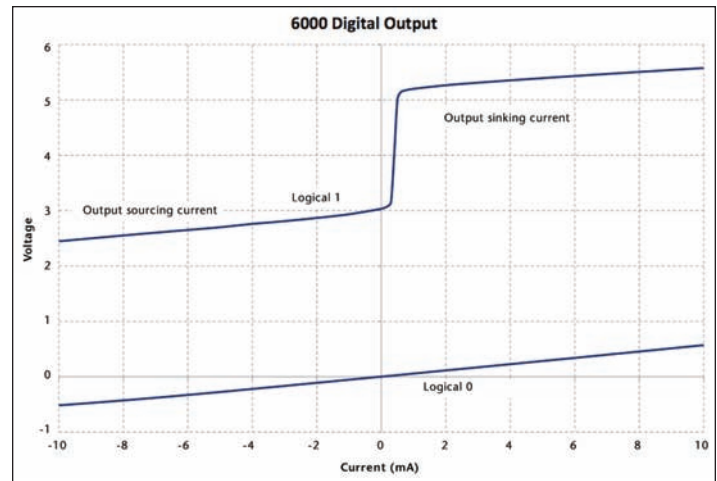

Counters

Channels: Up to 4 independent

Resolution: 32-bit

Input Frequency: 20 MHz max

Input Characteristics: 10 kOhm pulldown

Trigger Level: TTL

Minimum Pulse Width: 25 ns high, 25 ns low

Programmable Modes: Counter, encoder

Encoder Resolution: x1 (default), x2, and x4

Encoder Sources: There are 3 encoder sources (A, B, and Z) that be assigned to any digital pin x

Counter Source: Internal clock, timer 1, timer 2, and digital pin x; one source can be used in multiple counters

Counter Mode Options: Totalize, clear on read, rollover, stop at the top, increment, decrement, rising edge, falling edge

Counter Gate Options: Unused, internal clock, timer 1, timer 2, and digital pin x; one gate can be used in multiple counters

Safety

Safety Voltages

Only connect voltages that are within these limits.

Channel-to-COM: ±30 V max

Isolation Voltages

Channel-to-Channel

Within each Four-Channel Internal Module: No isolation between channels

Between each Four-Channel Internal Module: 250 V isolation

Note: There is no isolation between channels 1, 2, 3, and 4; no isolation between channels 5, 6, 7, and 8; and no isolation between channels 9, 10, 11, and 12.

Channel-to-Earth Ground Continuous: 250 Vrms, Measurement Category II

Note: Measurement Category II is for measurements performed on circuits directly connected to the electrical distribution system. This category refers to local-level electrical distribution, such as that provided by a standard wall outlet (for example, 115 V for U.S. or 230 V for Europe). Do not connect to signals or use for measurements within Measurement Categories III or IV.

1 Accuracy specifications are only valid when using provided connectors and properly installed backshells.

6222

Specifications & Ordering Information

Environmental

The 6222 is intended for indoor use only but may be used outdoors if installed in a suitable enclosure.

Operating Temperature: -40 to 50 °C

Storage Temperature: -40 to 85 °C

Ingress Protection: IP 40

Operating Humidity: 10 to 90% RH, noncondensing

Storage Humidity: 5 to 95% RH, noncondensing

Maximum Altitude: 2,000 m (6,562 ft.)

Pollution Degree: 2

Calibration

Calibration Interval: 1 year; contact factory for information regarding calibration service.

Note: The above calibration information pertains to hardware calibration, not to be confused with “user” or “software” calibration. When performing a “user” calibration via Encore (or other software) keep in mind that sample rate affects both gain and offset of the hardware, and therefore any “user” calibration should be performed at the same sample rate that is intended for measurements.

Ordering Information

Description

12-channel, 24-bit ADC, Ethernet-based thermocouple input module, with included *Out-of-the-Box* Encore software

Part No.

6222

Accessories & Cables

Universal power supply, 24 VDC @ 0.8 A (max); requires additional cable,

CA-1 (US) or CA-216 (European)

Required cable for use with TR-60U; 120 V US version

Required cable for use with TR-60U; 220 V European version

RJ12 shielded cable, 6 conductor, SYNC, 0.3 m (1 ft.)¹

Ethernet crossover cables, 2.133 m (7 ft.)^{2,3}

Ethernet patch cable, 0.457 m (1.5 ft.)²

Ethernet patch cable, 2.133 m (7 ft.)²

Backshell connector kit

Stacking plate kit

Handle kit

TR-60U

CA-1

CA-216

CA-74-1

CA-192-7C

CA-242

CA-242-7

CN-271

190658A-01

HA-210-5-BK

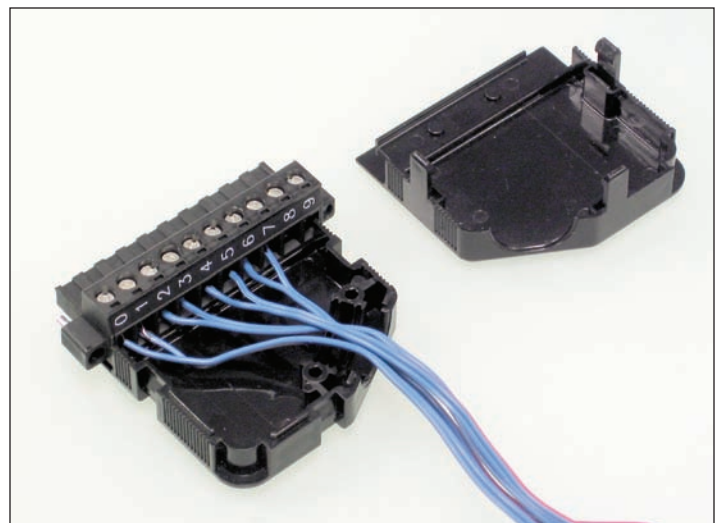
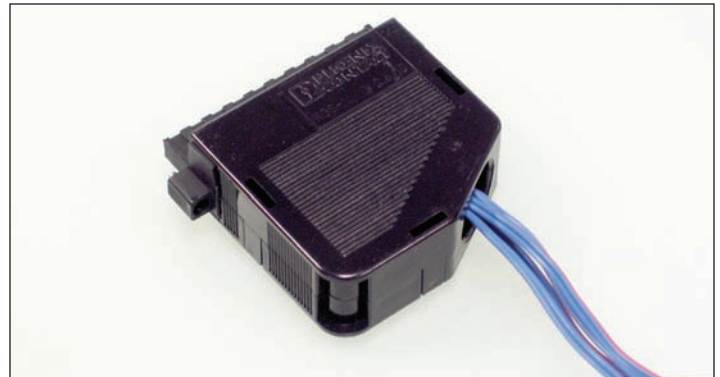

CN-271 connectors and backshells are included with the 6222 and provide internal screw-terminal connectors for wiring thermocouples

¹ Up to nine units can be synchronized. The total combined length of the SYNC cables is not to exceed 2.438 m (8 ft.).

² Ethernet cable length must be <3 m (9.8 ft.) in order for the system to be CE Compliant.

³ An Ethernet crossover cable must be used when connecting a 6000 Series device directly to the host PC.

Encore

Out-of-the-Box Software

Features

- Interactive measurement software for *Out-of-the-Box* setup, acquisition, display, logging, analysis, and reporting
- Included with 6000 Series Ethernet-based data acquisition modules
- Advanced feature set with no programming required
- Drag-and-drop functionality
- Easy-to-use set-up wizards
- Ability to drag data directly to Excel®
- Included data analysis tools
- Playback mode
- Sophisticated test report capability
- Incorporate multiple 6000 Series devices into one application
- Supported Windows® Operating Systems: Windows 7 (32-bit or 64-bit), Windows Vista (32-bit or 64-bit), Windows XP SP2 (32-bit), Windows 2000 SP4

Overview

Encore is the premier *Out-of-the-Box* data acquisition software package and is included with each 6000 Series module. Encore combines ease of use with advanced functionality, including customizable data layouts, powerful analysis, and reporting capabilities. Instead of having a program to log data, another to analyze, and a third to develop report data, Encore includes the functionality of all three into one package, thus shortening the learning curve, and saving time and cost.

Configuration

Easy-to-use set-up wizards provide rapid hardware configuration. Encore allows you to go from setup to taking measurements in minutes. Users can select one or more available devices from Encore's Hardware Configuration dialog.

Encore allows you to configure the basic acquisition or generation options, such as channel selection, acquisition rate, number of points, and input range. You can also configure start and stop triggers.

In addition, within the Channel View table, users can enable (or disable) channels, select measurement type, enable logging, perform mx+b calculation, and more. Channel View configurations can also be shared among multiple projects.

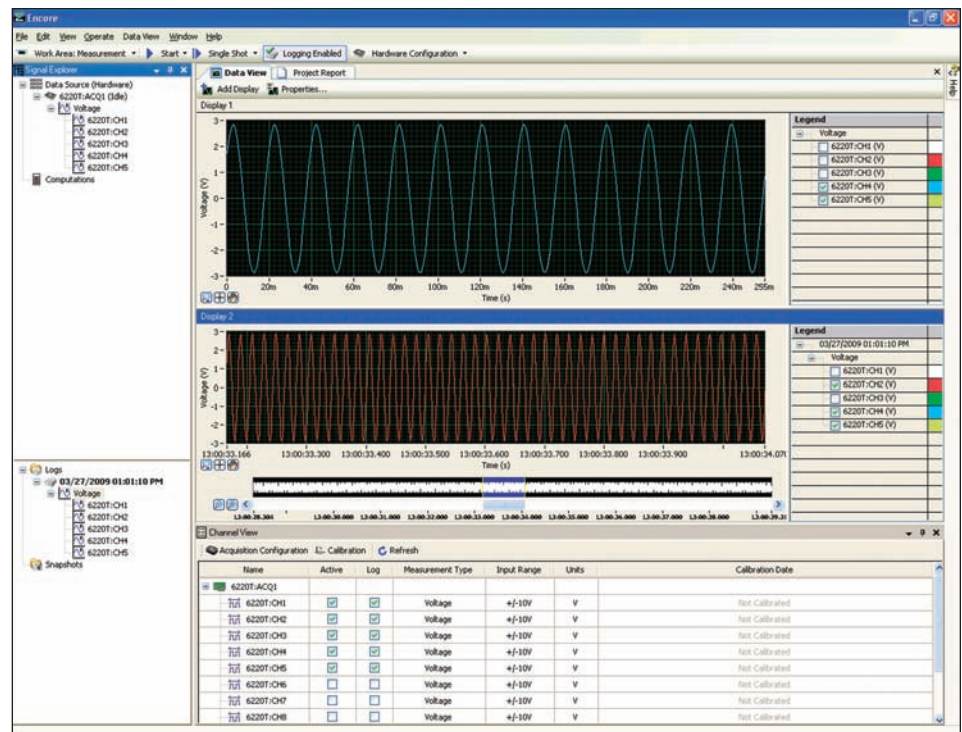

Encore offers an intuitive user interface. Data displays can be configured with multiple charts, overlapping data plots, and user selectable scales.

Measurement

Encore allows you to develop data displays quickly with an intuitive, drag-and-drop interface. Encore also offers the ability to easily change plot colors, overlay channels (including previously recorded data), and access multiple devices. You can also display data in a variety of ways including; charts and graphs, meters, gauges, and tanks. Additionally, you can export data to other formats including Excel, ASCII and DIAdem.

Triggering

A variety of programmable analog and digital trigger conditions are available for starting and stopping an acquisition within Encore. Analog triggers include Rising Edge, Falling Edge (with hysteresis), Above Level, Below Level, Inside Window, and Outside Window. Digital

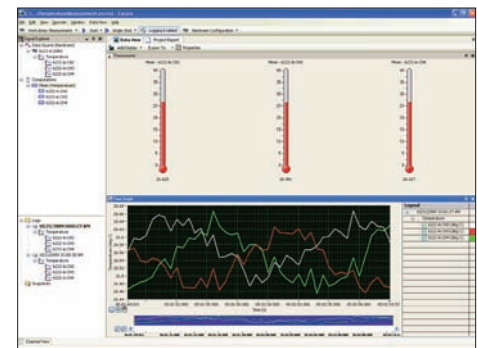

Encore can display channel data in several ways including meters, gauges, tanks and graphs

triggers include Rising Edge, Falling Edge, Level High, or Level Low. In addition, the Duration trigger may be used to stop an acquisition after a specified time.

Analysis

Included analysis options make Encore MCC's most advanced *Out-of-the-Box* software package. Features include FFT, power spectrum, statistics, peak value, and RMS calculation. In addition, you can also create custom formulas using Encore's Create Calculated Signal function. Data can also be viewed in the playback work area. Analysis can be computed on live data as well as logged data (post processing).

Analysis options include:

- Statistics: Standard Deviation, Mean, and Variance
- Peak: +Peak, -Peak, and Peak-Peak
- RMS
- DC
- FFT
- Power Spectrum
- Minimum
- Maximum

Export to Excel®

Signals can be exported from Encore to Microsoft Excel. When exporting signals from Encore to Microsoft Excel, the following information is exported:

- Signal name
- Export date and time
- Signal units
- Data values

Reporting

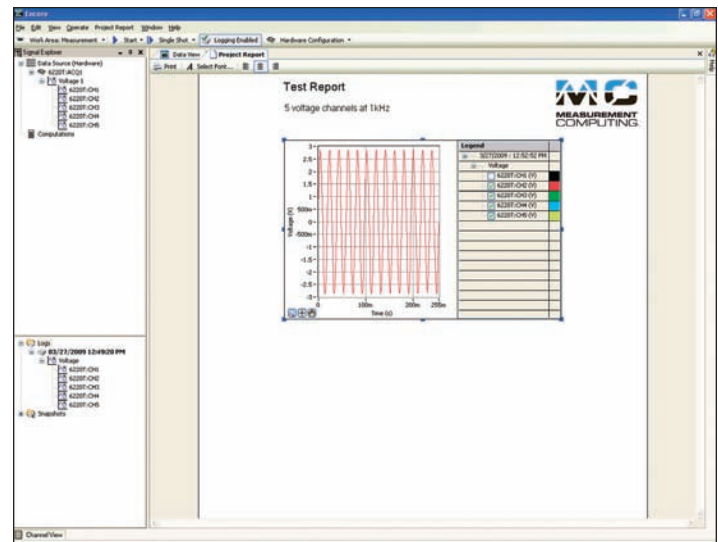

In the Project Report tab you can drag signals from the Signal Explorer, enter text, change fonts, import images, and print or export reports to html

Encore offers sophisticated, built-in test reporting capability which provides the ability to present data in a professional manner. With Encore's test report capability, users can easily develop in-depth test reports.

Within Encore's Project Report tab users can drag signals from the application directly into the report and then enter text, change fonts, import images and print or export reports. Once the report is complete, you even have the ability to acquire new data and easily update any previous report, without re-creating the report. The report can be edited throughout the life of the project.

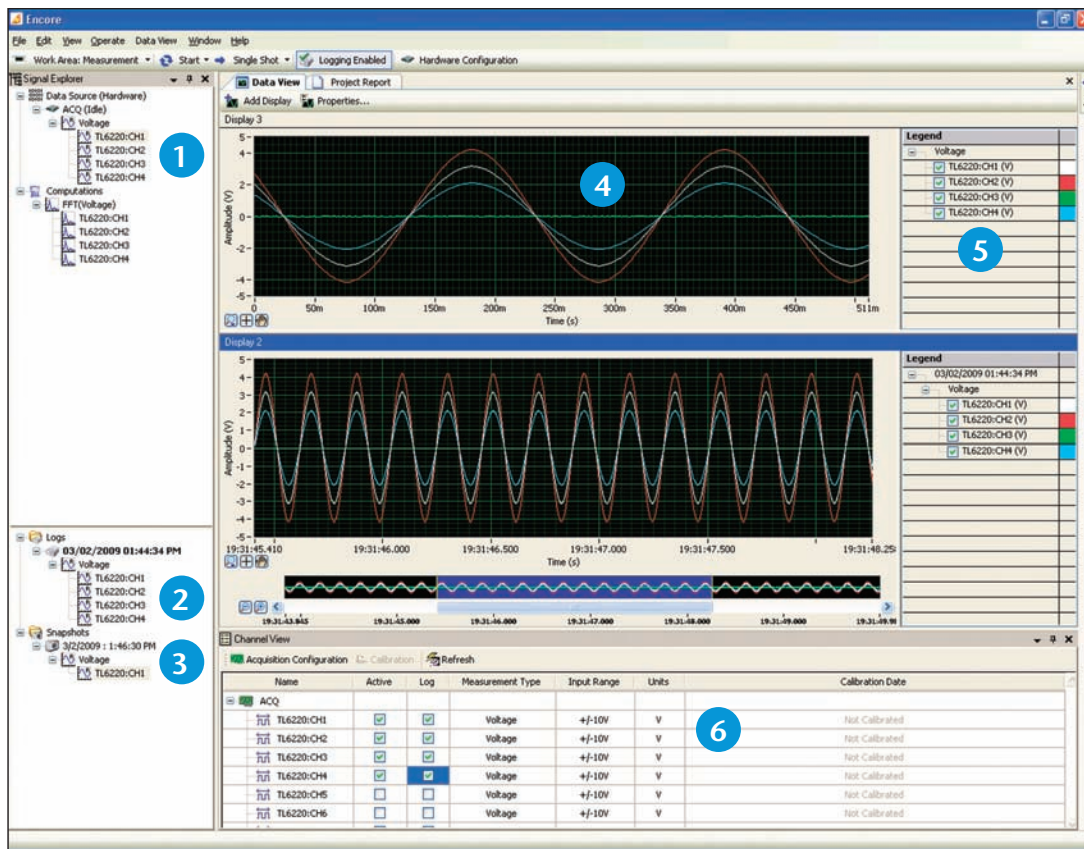

- 1 Signal Explorer** displays the data sources, computations, snapshots and logs available for your project. It also allows you to select and drag signals into the Data View. Signals can also be dragged directly Into Excel.
- 2 Log Window** displays a list of a project's logged data [including snapshots] sorted by the time at which you recorded the log or took the snapshot.
- 3 Snapshots** allow you to save a record of the current values of any signal in your project. You can use snapshots as a reference signal to compare data within the same or another project.
- 4 Data View** tab allows you to view your data by dragging signals directly from the Signal Explorer or the Log Window. The Data View tab can display signals in several formats, including graphs, charts, and various numeric representations. When you drag a signal to the Data View tab, the signal appears in a new or existing display depending on whether a display showing that type of data already exists.
- 5 Legend (Graph Legend)** lists every signal displayed in the graph and also shows its corresponding plot color.
- 6 Channel View** is a table-style section which gives you an overview of all your channels and their settings. You can enable (or disable) channels, select the measurement type, enable (or disable) logging, perform mx+b calculation, and more. You can also use the Channel View toolbar to quickly jump to Acquisition Configuration or [system] Calibration windows.