

Induction Motor Testing and Evaluation

Summary

As energy costs rise, more emphasis is being placed on determining the health of large inductive motors. Motor Current Monitoring and Analysis (MCSA) is a straight forward tool to diagnosing problems with large inductive motors. This technique along with standard vibration analysis, voltage monitoring, and temperature monitoring provides a complete diagnostic perspective of motor health and condition, power consumption, and overall efficiency.

Induction Motors and Energy Use

It is estimated that as much as 60 percent of total power generation capacity of the United States is consumed by electric motors. An EPA study completed in 1996 found that the 1 billion electric motors in the United States consume 1700 billion kWh per year. Of this total consumption, more than 80 percent is utilized by motors greater than 20 horse power; these large motors represent less than 1 percent of all motors in use.¹

As energy costs continue to rise, industry has great incentive to reduce operational costs by optimizing energy consumption. Obvious candidates for this optimization are large inductive motor systems, as

these are the greatest single segment of total power budget for most industries.

Optimization opportunities include carefully matching motor horsepower ratings to the requirements of the job, replacing older, low-efficiency motors with modern high-efficiency designs, and regulating motor operating speeds to control flow or process rates rather than utilizing dampers or diverter valves on constant speed systems.

The savings potential of such efforts can be substantial. An optimization program implemented by Minnesota Mining and Manufacturing (3M) involving 1000 electric motor systems resulted in a 41% net reduction in electrical consumption. This equates to 939,400 kWh annually, \$77,554.00 in fiscal 2002.²

Another area that can offer substantial savings is insuring that all motors in service are healthy. AC induction motors are subject to many different failure modes. Broken rotor bars, cracked end rings, high resistance joints (bad welds) excessive air gap eccentricity, and shorted stator windings are typical problems, particularly on large motors subjected to multiple start/stop cycles.

Motor Basics

While motor design and construction is beyond the scope of this article a brief review of basic principles is warranted.

Electric motors are effectively magnetic devices. As every youngster has discovered, if you have two magnets and hold them next to one another the opposite poles will attract, pulling the magnets together, and like poles will repel, pushing the magnets apart. This basic principle is utilized in all electric motors.

In motors, the first magnet is the stator, the second is the rotor. As the names suggest, the stator is the stationary portion of the motor, secured in the exterior enclosure or frame, and the rotor is the central, rotating part. When a rotating magnetic field is created in the either of these elements, and the rotor will be forced to move, keeping the magnetic poles aligned. These magnetic fields are created by passing electrical current through wire coils assembled into the motor. Dependent on the design of the motor the coils may be only on the rotor (the 'armature' in DC motors)



Molded Inductive Rotor Assembly with 22 Rotor Bars

with permanent magnets on the stator, a combination of stator and rotor windings (DC and AC motors), or a wound stator with an inductive rotor (AC motors).

High power AC motors are typically inductive in design. An inductive rotor is constructed by laminating iron disks together to form the central core of the rotor. Slots around the circumference of the core receive conductors, termed 'rotor bars' which are shorted together at either end of the rotor. This is accomplished by 'end rings' which may be welded to the ends of the rotor bars, or the end rings and rotor bars may be injection molded around the core, effectively forming a single, homogenous structure.

When the rotor is assembled inside of the stator, current flow through the stator windings generates corresponding 'induced' current flow through nearly aligned, adjacent rotor bars. This current path is completed by the end rings, creating a closed circuit. The induced current flow generates magnetic force in the rotor, compelling it to rotate to keep the stator and rotor fields aligned. The greater the misalignment, the greater the induced current and therefore the higher the electromotive force (*emf*) and torque generated.

Synchronous Motor Speed and Slip

An interesting characteristic of induction motors is that the actual speed of the rotor always lags the progression of the magnetic field around the stator. If the rotor is spun at exactly the same speed as the magnetic field generated by the stator windings, there is no induced current flow and therefore no *emf* is generated.

The magnetic field progression speed, also termed the "synchronous motor speed," is dictated by the line frequency of the supply voltage and the basic design of the motor. The value is calculated as:

$$\frac{2 * \text{line frequency}}{\text{number of motor poles}}$$

For a four pole AC motor operating on 60 Hz power, the synchronous motor speed is calculated as:

$$\frac{2 * 60 \text{ Hz}}{4} \\ = 30 \text{ Hz or } 1800 \text{ RPM}$$

The actual operational speed of the motor will be determined by the load applied. As load increases, the operational speed reduces and motor torque increases. The difference between the synchronous motor speed and actual motor speed is termed "slip."

Slip frequency is calculated by subtracting the actual operating speed of the motor from the synchronous speed. A four pole motor with an actual speed of 1659.36 RPM would therefore have a slip frequency of 140.64 RPM or 2.344 Hz.

Slip is also expressed as a dimensionless ratio calculated as:

$$\frac{\text{Slip Frequency}}{\text{Synchronous Motor Speed}}$$

Our example will therefore have a slip ratio of:

$$2.344 \text{ Hz} / 30 \text{ Hz} = 0.0781333$$

Motor Current Monitoring and Analysis

Motor Current Signature Analysis (MCSA) is a proven and accepted method for determining the condition of a motor's current carrying components. Testing can be conducted without interrupting the normal operation of the motor, and in fact should be performed when the motor is under a minimum of 70% load. The process is noninvasive, requiring only that a current transformer (amp-probe or current clamp) be placed around one conductor of the motor power supply cable. On three phase motors only one phase need be monitored as characteristic fault frequencies will be equally evident in all three phases.

In a healthy inductive motor the flow of current through the stator windings and conductive rotor bars and end rings is consistent and balanced, resulting in constant torque and minimal vibration. Damaged conductors cause a reduction or complete interruption of current flow, and a corresponding reduction in torque as that winding is energized. This momentary drop in current repeats periodically with each rotation of the rotor, resulting in modulation of the current drawn by the motor. Vibration will increase, and localized heating will occur, potentially distorting the rotor and further aggravating the vibration problem. Conductors adjacent to the damaged winding or rotor bar will be required to 'pick up the slack' to maintain the torque required from the motor. Current flow through these conductors will increase, resulting in additional heating and possible cascading of failure.

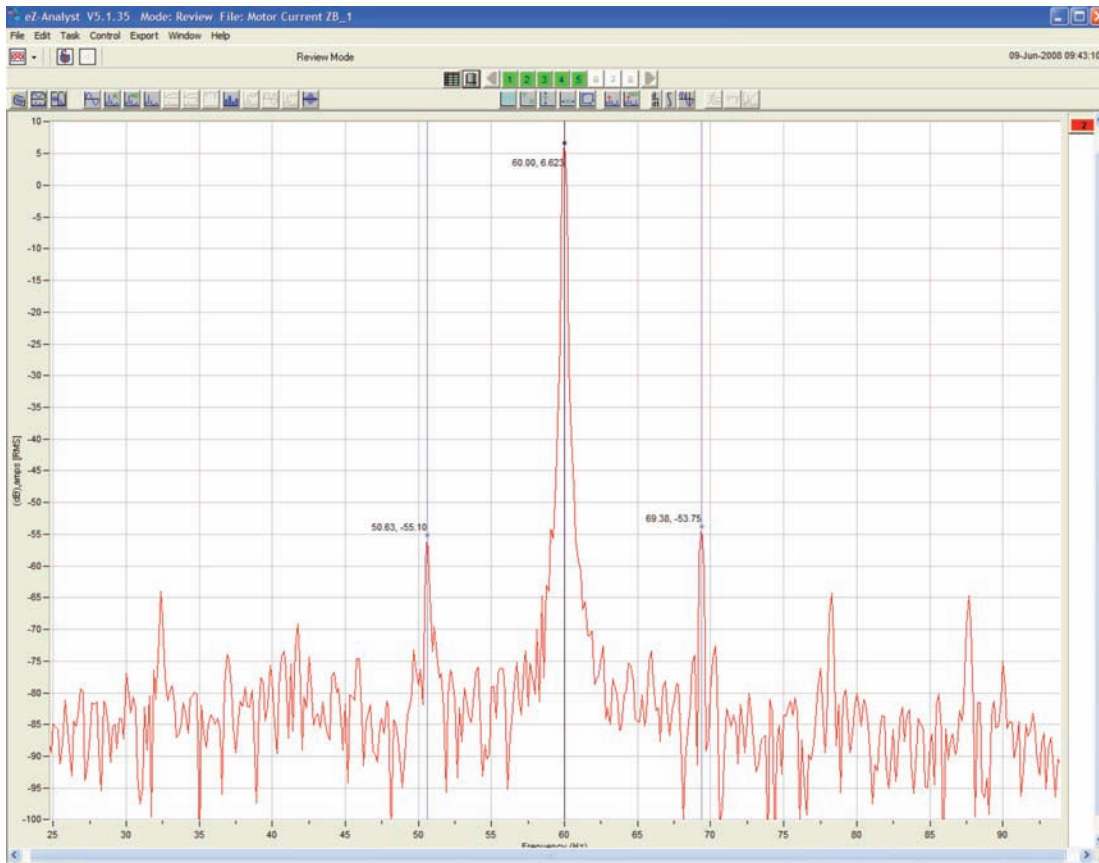

Current Spectrum Sidebands

When the motor current signal is processed through a spectrum analyzer evaluation of the resultant spectrum can identify and quantify the severity of specific motor faults. Slip frequency will be visible in the current spectrum in the form of sidebands around the line center frequency. These sidebands will be evident in a log spectrum plot, even on healthy motors, and will occur at twice the slip ratio. Increases in the amplitude and number of these slip sidebands is a reliable indicator of rotor health.

Above is a screen capture of our example motor operating at 27.656 Hz. We have previously calculated the slip ratio as 0.0781333. The sideband calculation is as follows:

$$\text{sideband freq} = (1 \pm 2 * \text{slip ratio}) \text{ line frequency} =$$

$$(1 + 2 * 0.0781333) 60 \text{ Hz} = 69.376 \text{ Hz}$$

$$(1 - 2 * 0.0781333) 60 \text{ Hz} = 50.624 \text{ Hz}$$

Slip sidebands with an amplitude of -55 dB to -60 dB are normal for healthy induction motors. When the level increases to more than -40 dB electrical problems are indicated.³

Combining MCSA with vibration, voltage and temperature monitoring provides a complete diagnostic perspective of motor health and condition, power consumption, and overall efficiency.

Motor Current Speed Analysis Implementation Example

As shown, MCSA is a key tool to evaluating the health of inductive motors – it also can be automated for more efficient testing. The following example shows how to automate the MCSA test using DASYLab and the IOtech 600 series DSA products.

DASYLab was chosen as a programming tool because it is icon-based and easily learned and mastered. The program allows the user to construct customized application software including data collection and control, analysis, display and storage.

DASYLab can be easily configured to perform as a spectrum analyzer. FFT Windowing and analysis modules are combined with a Y/T display to duplicate the functionality of a dedicated spectrum analyzer. Briefly, when performing frequency analysis in DASYLab, the sample rate selected will determine the maximum frequency that can be presented in the FFT. The Block size will determine the base resolution of the frequency data. As an example, if sample rate is set to 2,000 samples per second (s/s) the highest frequency represented in the spectrum will be ½ the sample rate or 1,000 Hz.

DASYLab processes data in 'blocks' of contiguous samples. By default the block size is set to roughly ½ second of data, utilizing a binary increment. In our 2,000 s/s example, the default block size will be set to 1024 samples. Therefore, the base resolution of an FFT will be $1000 \text{ Hz}/1024 = 0.977 \text{ Hz}$.

Analysis Worksheet Construction

An example worksheet would appear as below:

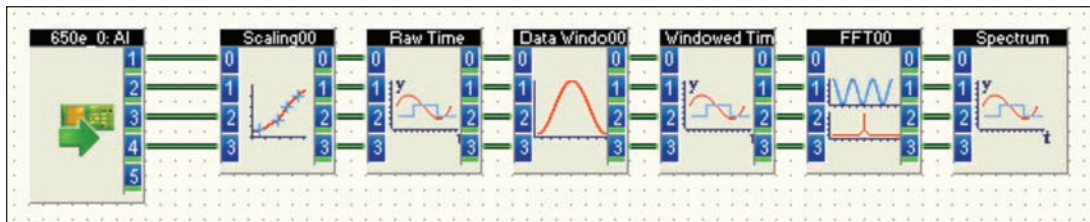

Starting from the left, the first module is the Analog Input of a 650 DSA unit. The channels have been defined as Voltage, Current, Vertical Acceleration, and Horizontal Acceleration. IEPE current has been enabled on channels 3 and 4 to provide power to the accelerometers. An Isolation Voltage Probe is connected to channel one, a Current Probe is connected to channel two, and 100 mV/g accelerometers are connected to channels three and four.

The second element is a Scaling Module. This converts the raw voltage level received from the sensors into user units of Voltage, Current, and Acceleration.

A Y/T Display follows the Scaling Module, allowing the user to observe the incoming raw time domain data.

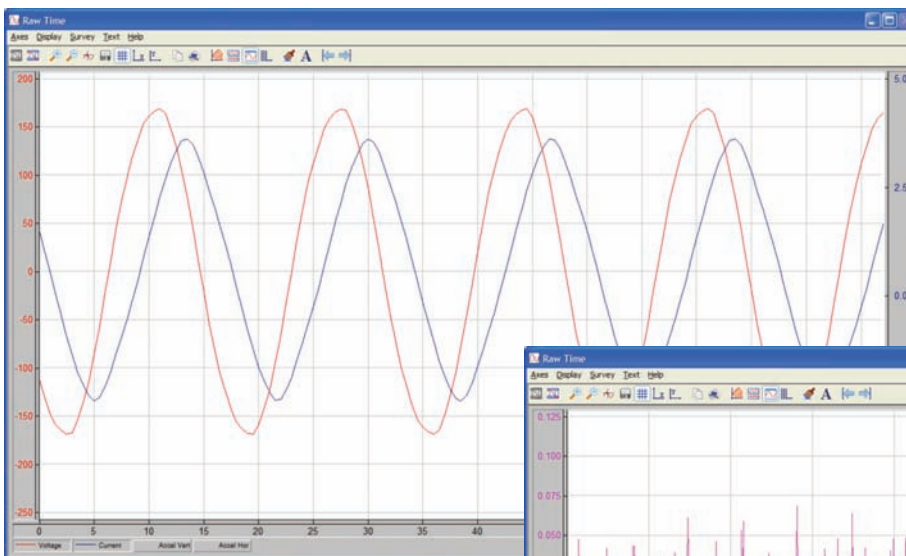

Voltage (red) and Current (blue) Raw Time Display – Note Current Lag

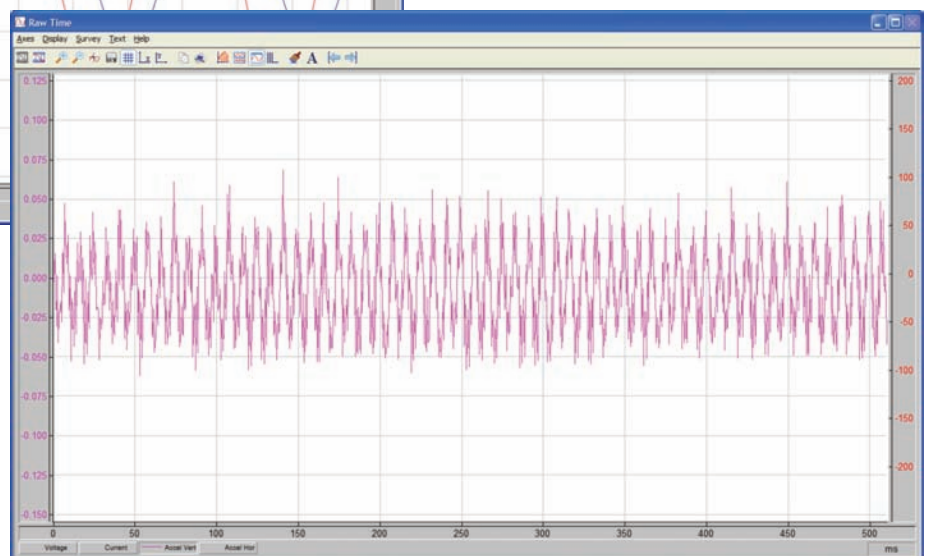

Vertical Acceleration Raw Signal Display

The fourth element is an FFT Data Window. A data window is utilized to both filter and accumulate enough raw data points to provide adequate resolution within the spectral data. For Motor Current Spectral Analysis the FFT resolution must be high enough to separate closely spaced frequencies associated with slip. Note that the block size has been increased to 8192 and specifies an 80% overlap. This permits the FFT resolution to increase to $1000 \text{ Hz} / 8192 = 0.122 \text{ Hz}$.

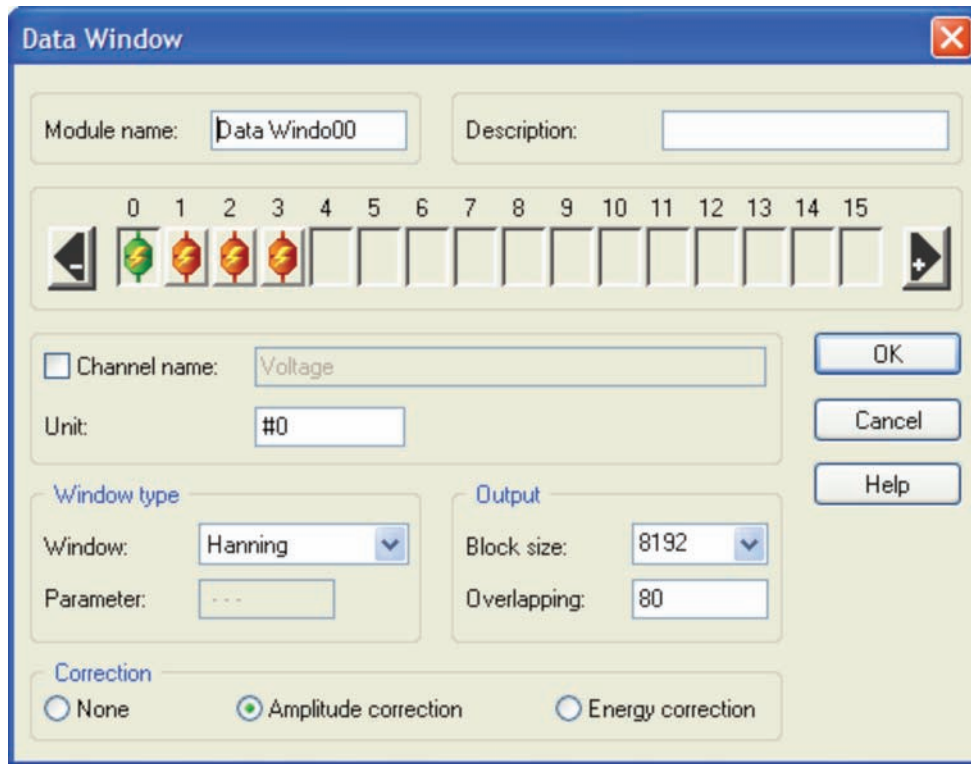

FFT Data Window Setup Dialog

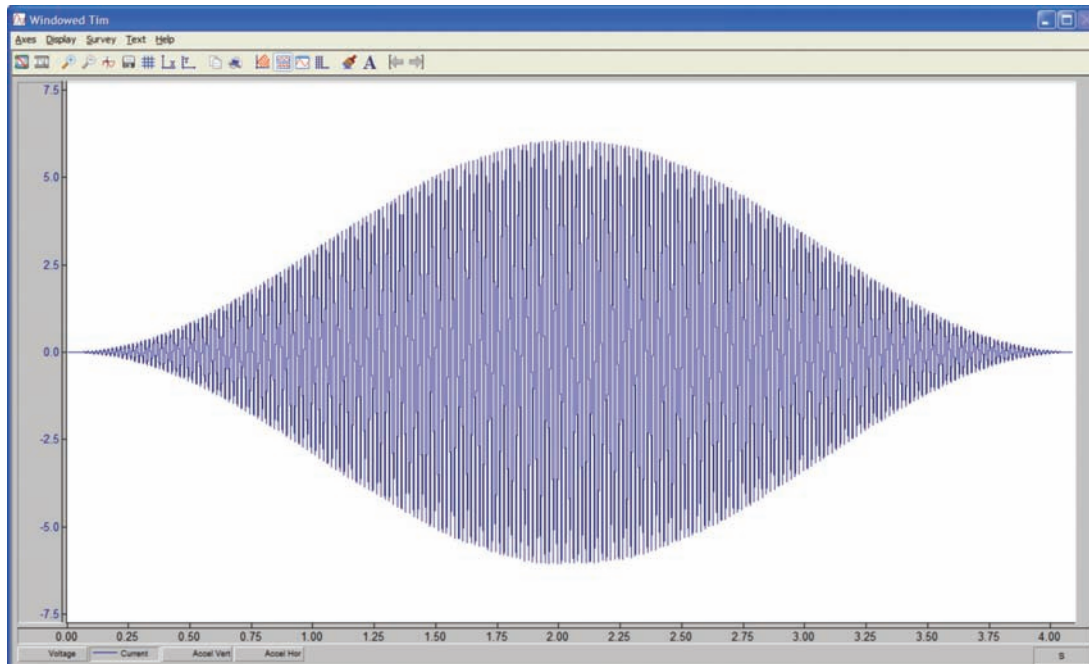

Current Displayed in Windowed Time View. Note Time Scale (4.096 sec.)

Immediately following the FFT Window module is another Y/T display to allow us to view the windowed time domain data. The data is then passed into an FFT Analysis Module.

The FFT Module provides options for scaling the output data into dB units for display. The dB reference level can be specified, or the analysis can be set to utilize the highest value received in the block as the zero reference. The final module is a third Y/T plot of the resultant spectral data.

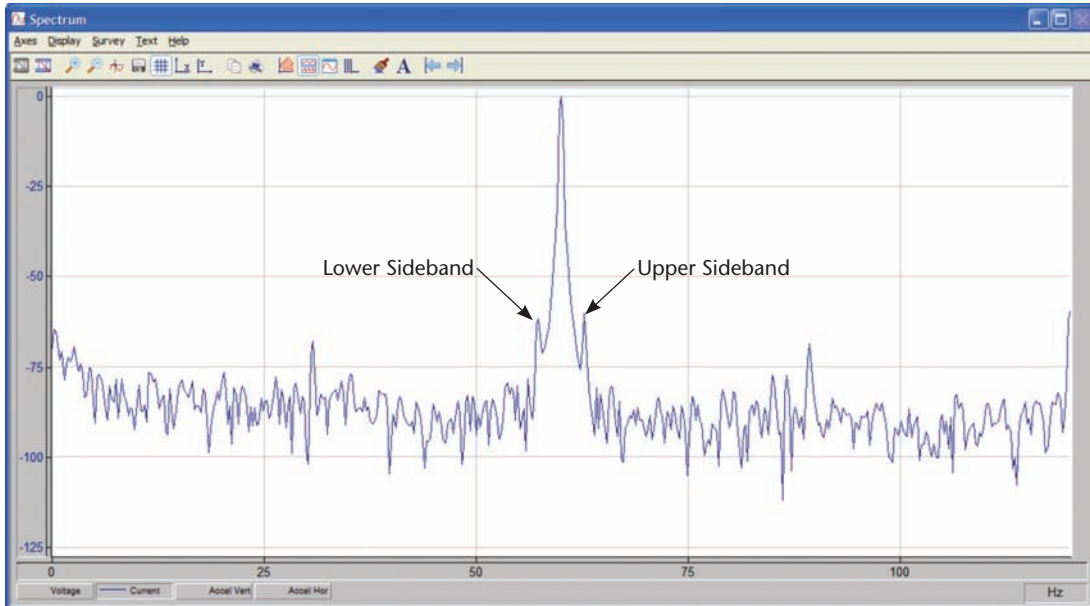

Zoomed Y/T Spectrum Display, No Load Applied

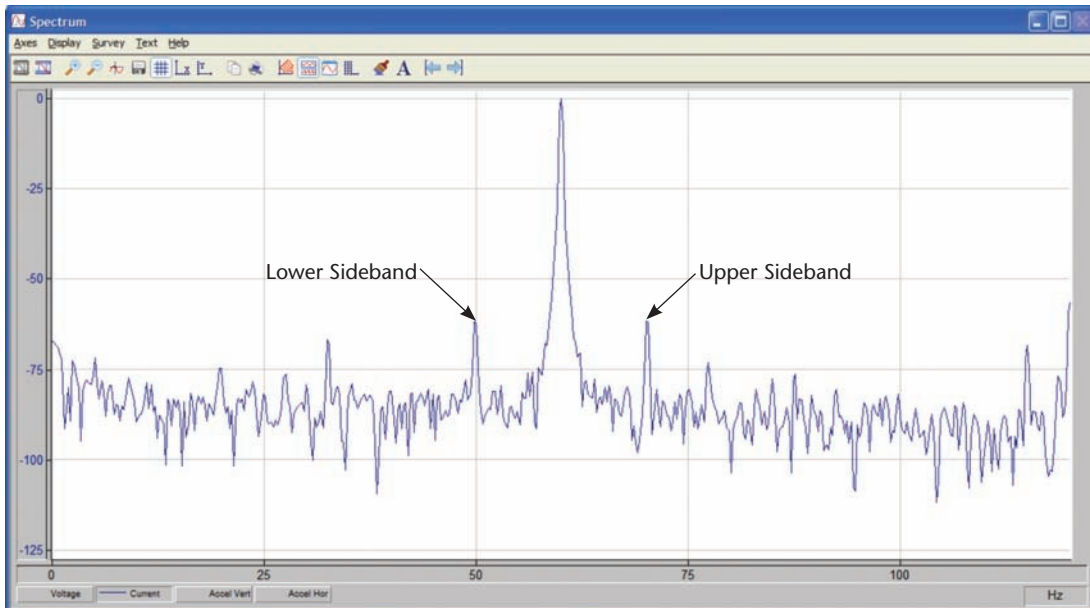

Same Display with Load Applied – Note Slip Sidebands

Adding Speed Monitoring

Operating speed of the motor can be monitored by using the fifth channel of the 650 as a tachometer input. A laser tach is connected to channel five, a reflective target is placed on the motor output shaft, and the pulses are then evaluated to determine motor operating speed.

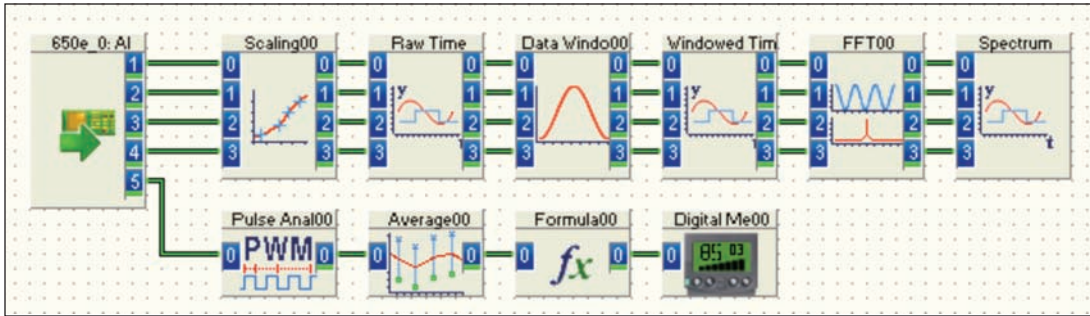

Adding Speed Detection on Channel Five

The PWM Module detects rising edges on the incoming pulse train and then reports frequency directly in Hz. The second module is used to average these values together over several blocks of data, providing much improved resolution of the frequency data. The formula module then multiplies the frequency by a factor of 60, converting Hz to RPM. The final element is a Digital Display to present the value to the user.



RPM No Load



RPM With Load

Electrical Characteristics Module Overview

The Electrical Characteristics module calculates 14 different parameters based on AC Voltage and Current inputs. Additionally, the first output reports the number of sample points utilized for the calculations, and the last output will provide an error code if problems such as loss of input signal occur.

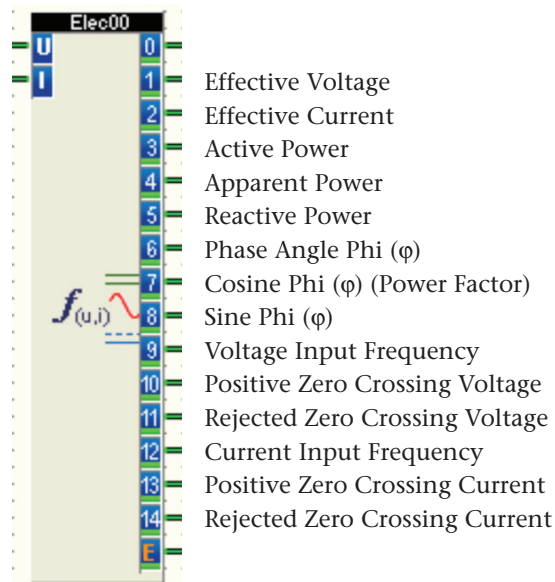

Adding The Module

The module will be connected to the Voltage and Current signals, after these have passed through the Scaling Module. A digital display is again added to allow the user to view the calculated results.

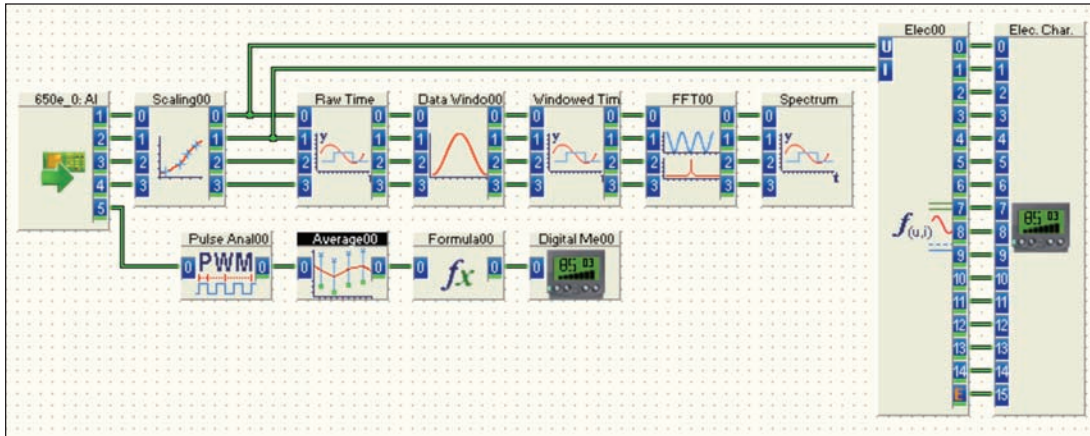

Adding Electrical Characteristics Analysis & Display

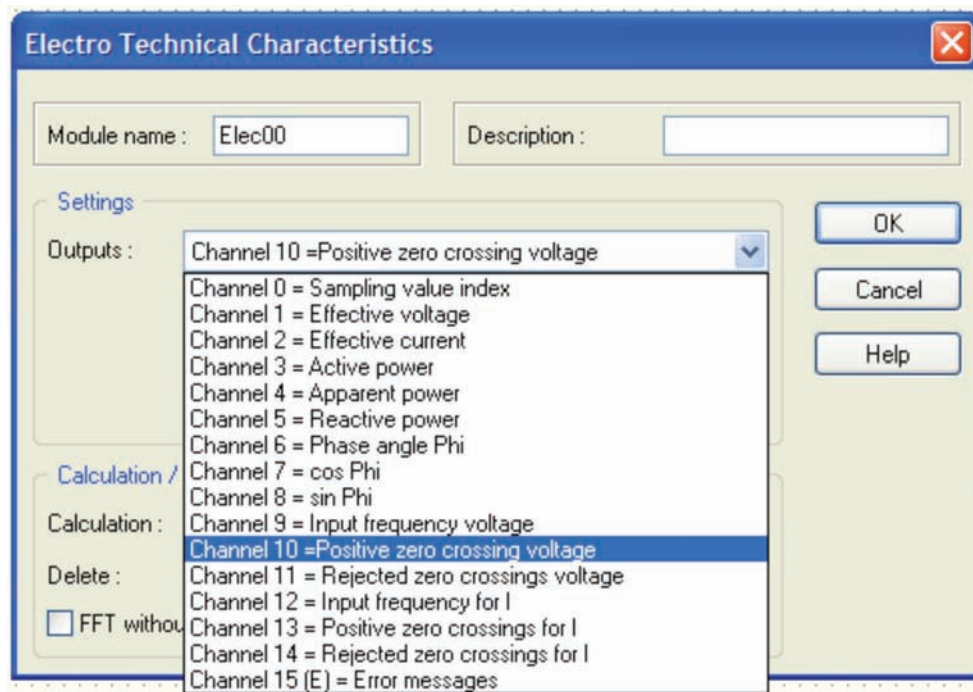

Setup Dialog for Electrical Characteristics Module

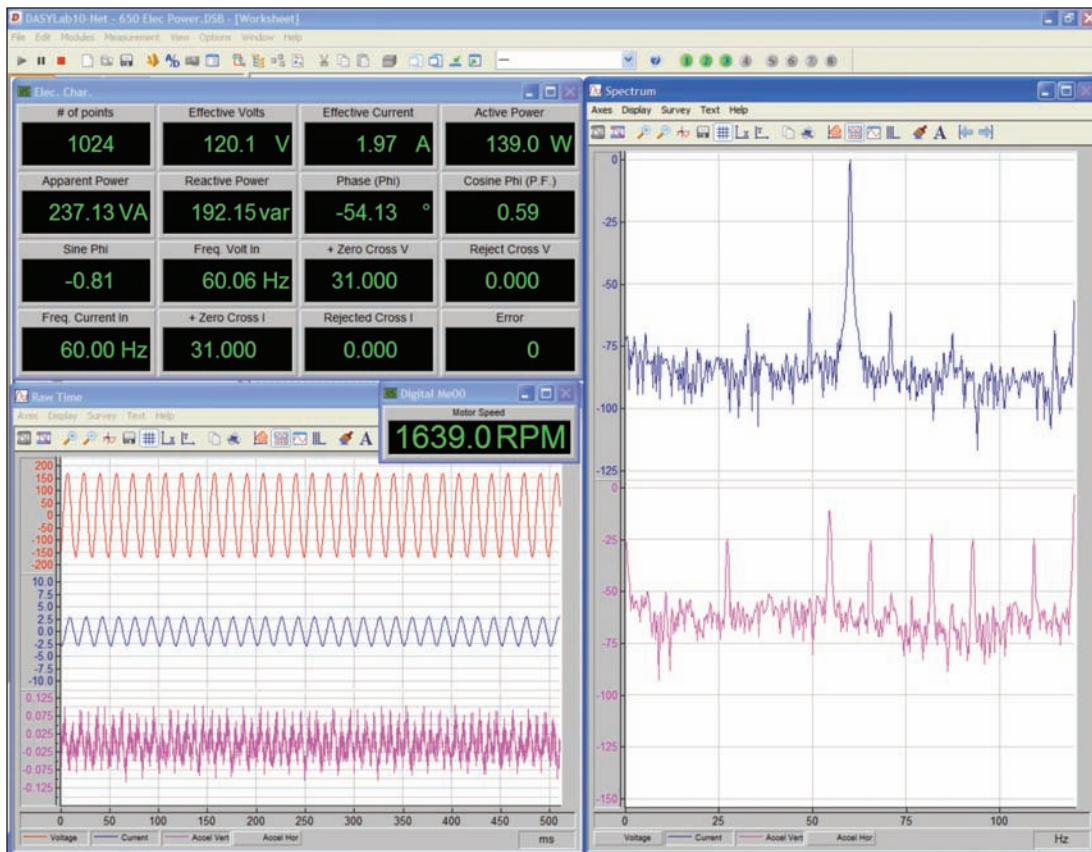

Desktop with Multiple Displays Active

Summation

Motor Current Monitoring and Analysis is a straight forward approach to inductive motor testing. Combining MCSA with standard vibration analysis techniques, and utilizing DASyLab's Electrical Characteristics Module provides a complete view of over-all motor performance and health. Configuration is straightforward and easily accomplished.

REFERENCES:

1. Turner, M.W., McCormick, V.E., and Cleland, J.G., "Project Summary, Efficiency Optimization Control of AC Induction Motors: Initial Laboratory Results," *United States Environmental Protection Agency, Research and Development, EPA/600/SR-96/008* (May 1996)
2. Best Practices Technical Case Study, "Optimizing Electric Motor Systems At A Corporate Campus Facility," *United States Department of Energy, Office of Industrial Technologies Energy Efficiency and Renewable Energy, DOE/GO-102002-1502* (May 2002)
3. Thompson, William T., and Gilmore, Ronald J., "Motor Current Signature Analysis to Detect Faults in Induction Motor Drives – Fundamentals, Data Interpretation, and Industrial Case Histories," *Proceedings of the Thirty-Second Turbomachinery Symposium - 2003*

Voltage and Current Probes

Adding voltage and current measurement capabilities to a data acquisition system is not a complicated process, but it does require the addition of appropriate probes for signal connection.

Data acquisition systems are typically no more compatible with the high voltage levels present in motor drive circuits than maintenance professionals are. Connecting even 110 VAC directly into an acquisition device is likely to result in a brief but quite exciting and expensive pyrotechnic display. Commercially available probes are required to isolate both the user, and the acquisition system from potentially lethal voltage levels, and attenuate these voltages to levels compatible with instrumentation inputs.

Probes are available from multiple instrumentation manufacturers. Tektronix, BK Precision, Fluke, and many others offer probes as accessory items for oscilloscopes and hand-held meters. These serve equally well when used with data acquisition devices.

Current probes are intrinsically safe devices, if used carefully and correctly. These devices are simply placed around the insulated electrical cable and are not in direct contact with high voltage potential. The probe acts as the secondary in a transformer circuit. Current flow through the power cable produces a proportional current flow in the probe. This current is converted to a low level voltage across a shunting component. Voltage levels at the output of the probe will typically be in the range of 1 to 5 volts, dependent on manufacturer and design.

Two basic current probe designs are available, inductive and Hall effect. Inductive probes are useful when measuring only the current level as peak or RMS, however, these probes introduce phase shift in the output voltage signal. Phase accuracy is extremely important in power measurement and spectral investigation, making inductive probes inappropriate for these applications.



High Voltage Isolation Probe and Clamp-on Current Probe

Hall Effect probes utilize a semiconductor that converts magnetic field strength directly into a proportional voltage signal. Response to field strength changes resulting from current variations is instantaneous, allowing highly accurate amplitude and phase measurement.

Whenever direct connection to high level voltage potentials is attempted. Isolation probes are required. As with current probes, two basic designs are available. Passive voltage isolation probes are typically inductive, utilizing a step-down transformer to both isolate the input from output and reduce the voltage to appropriate levels. Passive voltage probes have the advantage of not requiring batteries or an external power source, but they are not compatible with DC voltages and also introduce phase changes to the output signal. As discussed previously,

this characteristic restricts their utility for power and spectral measurement.

Active differential designs which maintain phase alignment utilize optical or frequency modulated isolation barriers. These probes require power and utilize electronic circuitry to attenuate and convert the incoming voltage level to a proportional digital frequency. This frequency signal is then coupled across an isolation barrier. Once passed to the non-isolated side of the barrier, the signal is converted back to a voltage level by frequency to voltage components. Active differential probes have excellent common mode rejection characteristics and frequency response. Models are available in several voltage ranges, some approaching 5,000 volts, and most support at least two attenuation selections.

SAFETY WARNING!

Voltage measurements require direct connection to voltage carrying components and potentially lethal high-voltages may be present. Extreme caution and strict adherence to accepted safety practices must be exercised to prevent injury or death.

IOtech 600 Series

Vibration data acquisition, analysis, and monitoring have never been easier than with the IOtech 600 Series of dynamic signal analyzers and eZ-Series software. More than 30+ years of engineering experience in vibration measurements have gone into the design of the 600 Series of DSAs. They come in either USB or Ethernet versions for maximum flexibility. The DSA hardware provides signal conditioning and data acquisition, while the eZ-Series PC-based software provides monitoring and analysis functions.

Common Features

- Dedicated 24-bit, 105.4 kS/s delta sigma ADC per analog input
- Spurious-free dynamic range of 108 dB (typical)
- AC/DC coupling, software selectable per channel
- TEDS support for accelerometers
- Pseudo-differential input
- Total harmonic distortion of -100 dB (typical)
- Channel-to-channel phase matching of <math><0.12</math> degrees at 1 kHz
- 8-bit digital IO port
- Supported Operating Systems:
Windows 2000®, Windows Vista® x86 (32-bit), and Windows XP®
- Supported by Vibrant Technology ME'scope software for Modal Analysis (excluding 655u)

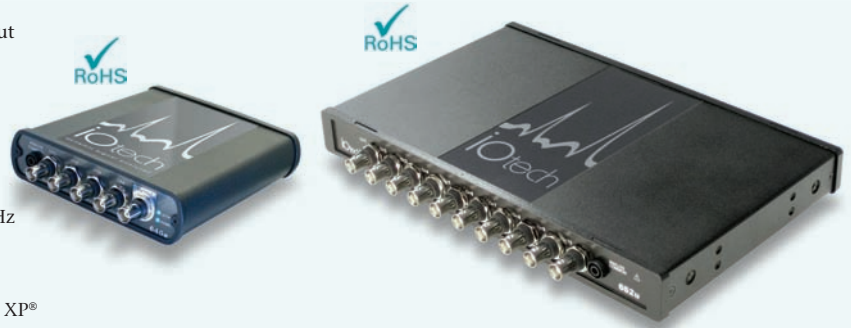

Vibration analysis and monitoring has never been easier than with the 600 Series of dynamic signal analyzers and eZ-Series software

640 Models

- USB or Ethernet interface
- 4 analog inputs, $\pm 10V$ input range ($\pm 60V$ max without damage)
- 2.1 mA IEPE current source per channel (22V compliance)
- 1.0 Hz high-pass filter
- 24-bit delta sigma DAC analog output
- Analog outputs: sine, swept sine, random, burst, arbitrary
- Analog output signal-to-noise ratio: 100 dB (typical)

650 Models

- USB or Ethernet interface
- 5 analog inputs, $\pm 40V$ input range ($\pm 60V$ max without damage)
- 2.1 mA IEPE current source per channels 1-4 (22V compliance)
- 0.1 Hz high-pass filter

652u Model

- USB interface
- 10 analog inputs, $\pm 40V$ input range ($\pm 60V$ max without damage)
- 4 mA IEPE current source per channels 1-10 (22V compliance)
- 0.1 Hz high-pass filter

655u Model

- USB interface
- 10 analog inputs, $\pm 40V$ input range ($\pm 60V$ max without damage)
- 4 mA IEPE current source per channels 1-10 (22V compliance)
- 0.1 Hz high-pass filter
- 5 temperature channels

Software Overview

Four software packages are available for the 600 Series, each tailored to a particular vibration measurement and analysis application. Choose the package that suits your application now, and upgrade to additional packages as your requirements evolve.

- **eZ-Analyst** provides real-time multi-channel vibration analysis, including overlay of previously acquired data while acquiring new data, strip charts of the throughput data files, cross channel analysis, and direct export to the most popular MODAL analysis packages, ME Scope and Star Modal.
- **eZ-TOMAS** provides on-line vibration recordings, limit checking, storage, and analysis of rotating machinery. Order track, Waterfall, Orbit, Polar, Bode, Spectrum, and Trend displays show machine startup or shutdown events, as well as diagnose long-term changes in machine health.
- **eZ-Balance** is used to balance rotating machinery with up to seven planes. A balance toolkit, including Split Weight calculations, supports the balance process. The balance vectors are displayed on a polar plot so the user has a visual indication of the improvement. Time and spectrum plots show detailed vibration measurement during the balance process.
- **eZ-NDT** package is exclusively used in production applications to determine the quality of composite-metal products at production rates of 1 part per second.

600 Series, eZ-Analyst, eZ-Balance, eZ-NDT, and eZ-TOMAS, are the property of IOtech. All other trademarks and tradenames are the property of their respective holders. 080607.

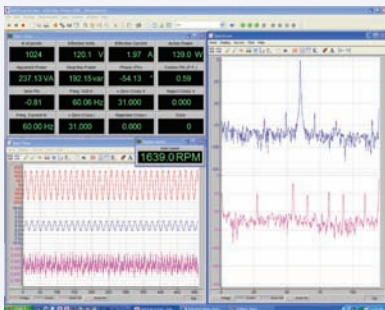

DASyLab® – Data Acquisition System Laboratory

- **DASyLab Lite** includes all drivers; comes without analysis, limited module count, and one Layout Window
- **DASyLab Basic** includes all drivers; comes with all standard modules (except Signal Analysis and Actions), and one Layout Window
- **DASyLab Full** includes all drivers; comes with all standard modules, 200 Layout Windows, and Control Sequencer
- **DASyLab Pro** includes all drivers; includes Full version plus all add-on modules (without third-party modules)