

# Ethernet-Based Voltage Measurement Module

## Features

- 12 voltage inputs
- 16-bit, 100 kHz per channel sample rate
- $\pm 10$  V input range
- Eight digital I/O
- Simultaneous sampling
- BNC connectors
- Multiple trigger modes
- Compact, portable design
- Expandable using multiple 6000 Series modules



## Software





- Includes Encore interactive measurement software for *Out-of-the-Box* setup, acquisition, display, logging, analysis, and reporting
- Advanced feature set with no programming required
- Drag-and-drop functionality
- Easy-to-use set-up wizards
- Ability to drag data directly to Excel®
- Included data analysis tools
- Playback mode
- Sophisticated test report capability
- Incorporate multiple 6000 Series devices into one application
- Supported Windows® Operating Systems: Windows 7 (32-bit or 64-bit), Windows Vista (32-bit or 64-bit), Windows XP SP2 (32-bit), Windows 2000 SP4

## Overview

The 6000 Series combines accurate, instrument class, Ethernet-based modules with powerful, easy-to-use software. It is a major advancement in ease of use and functionality. 6000 Series modules feature integrated signal conditioning and a modular design that allows for system expansion. Because they use an Ethernet connection, modules can be connected directly to a PC or used in remote configurations utilizing multiple modules.

Each 6000 Series module includes Encore interactive measurement software. Encore couples ease-of-use with advanced functionality including custom data displays, powerful analysis, and detailed reporting capabilities.

The 6220 with Encore software is a portable, voltage measurement solution

6000 Series Module Overview					
	6220	6222	6224	6230	6231
Feature					
Analog input type	voltage	thermocouple	strain gage/bridge	voltage	voltage
Analog inputs	12	12	12	12	12
Digital I/O	8	8	8	8	8
Resolution	16 bit	24 bit	24 bit	24 bit	24 bit
Sample rate	100 kHz per channel	2 Hz	50 kHz per channel	50 kHz per channel	50 kHz per channel
Voltage input range	$\pm 10$ V	$\pm 80$ mV	$\pm 25$ mV/V	$\pm 10$ V	$\pm 60$ V
Connector type	BNC	screw-terminal	RJ50	screw-terminal	screw-terminal
Ch-to-ch isolation	—	—	—	Yes	Yes

## Analog Inputs

The 6220 is equipped with 12 analog input channels with a  $\pm 10$  V range. Each analog input provides 16-bit resolution with a maximum 100 kHz per channel sample rate. All channels are sampled simultaneously.

## Digital I/O

The 6220 includes eight digital I/O lines. All eight lines are accessible via a 9-pin female DSUB connector located on the rear panel of the unit. Each digital I/O bit can be programmed individually to be either an input or an output.

## Counters

There are four 32-bit counters built into each 6000 Series module. They are accessed through the 9-pin female DSUB connector located on the rear of the unit. Each counter has a maximum 20 MHz input frequency and can be used in counter or encoder (A, B, and Z) modes.

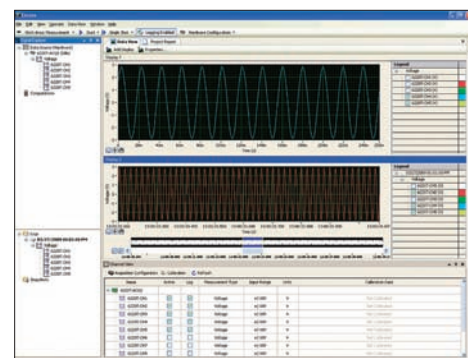

Encore provides real-time viewing and analysis of data along with built-in test report capabilities

## Triggering

A variety of trigger modes are supported by the 6220. A wide selection of programmable analog and digital trigger modes are available for starting an acquisition. All trigger modes, along with the number of scans and the sample rate for pre- and post-trigger data, are software programmable prior to the start of a scan sequence.

# 6220

## General Information

### 6220 System Examples

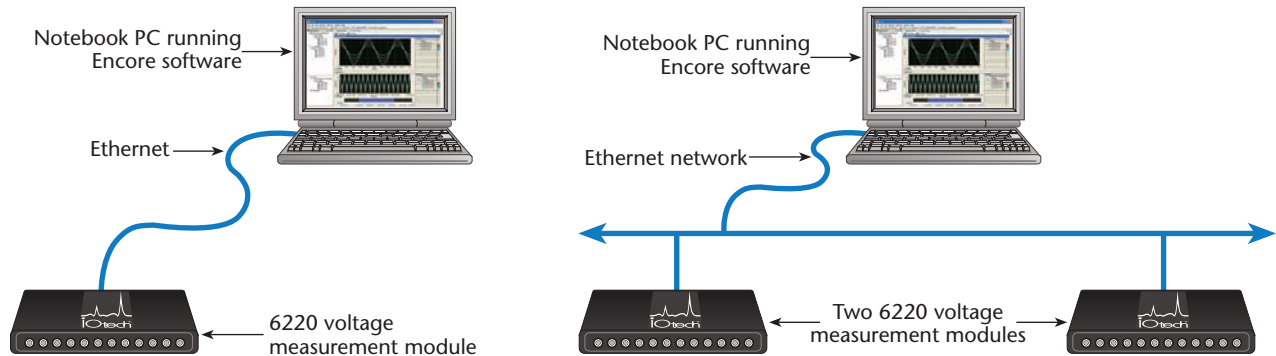

### System Power Connection

The 6220 and other 6000 Series modules offer the flexibility to be powered either directly from a 19 V to 30 VDC source, or via the included TR-60U AC power adapter.

### Ethernet Features

The 6000 Series transfers acquired data to the PC via 10/100BaseT Ethernet, allowing a continuous stream of data to be collected and stored in a PC's memory or hard drive. The most common and highest-performance connection is with dedicated, point-to-point Ethernet link between the PC and the 6220. With an enterprise-wide Ethernet network connection, any number of 6000 Series modules can be connected to the network.

### Multi-Unit Synchronization

Multiple 6000 Series modules can be synchronized via the rear-panel SYNC ports on each unit. After connecting each module to an Ethernet port, simply connect multiple 6000 Series modules together using SYNC cables (CA-74-1). Encore software provides the capability of setting one of the 6000 Series modules as the master and the others as slaves. The sampled data phase relationship among channels between multiple devices is dependent on the "Channel SYNC Skew" specification for each device.

### 6220 Block Diagram

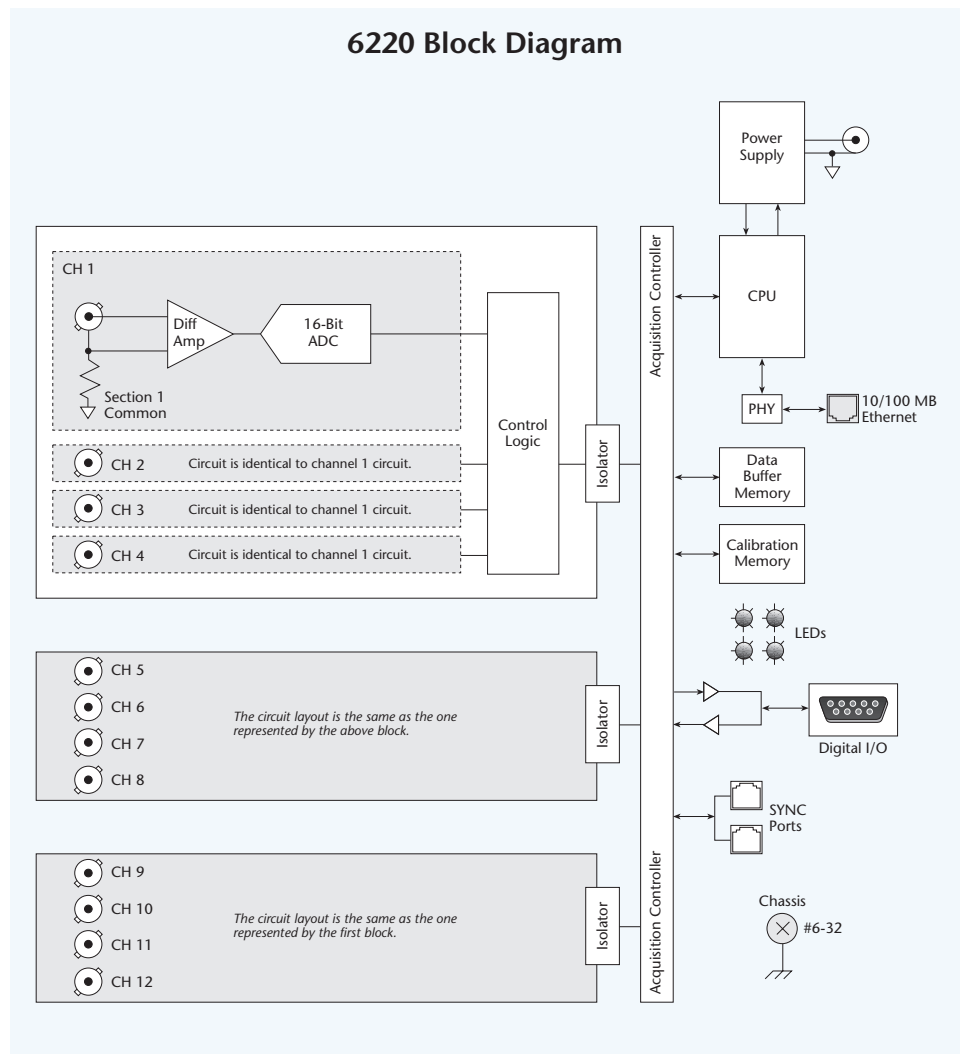

# 6220

## Specifications and Ordering Information

### Specifications

The following specifications are typical for the temperature range -40 to 50 °C unless otherwise noted.

#### Input Characteristics

**Number of Analog Channels:** 12  
**ADC Resolution:** 16 bits  
**Type of ADC:** Successive approximation register (SAR)  
**Input Range:** ±10.0 V nominal; overflow will occur if  $|V_{in}| \geq (10.2 \text{ V to } 10.6 \text{ V})$   
**Sampling Mode:** Simultaneous  
**Data Rates (fs):** 1 S/s to 100 kS/s (16 selectable rates)  
**Multiple Device, Channel Sync Skew:** 10 µs  
**Single Device, Channel-to-Channel Matching (Calibrated):** 100 ns typical  
**Overvoltage protection** ±30 V

#### Accuracy

Measurement Conditions	Percent of Reading (Gain Error)	Offset Error
Calibrated, max (-40 to 50 °C)	0.2%	±8.5 mV
Calibrated, typ (25 °C, ±5 °C)	0.02%	±1.4 mV

#### Stability

**Gain Drift:** 10 ppm/°C  
**Offset Drift:** 60 µV/°C  
**CMRR (f<sub>in</sub>=60 Hz):** -73 dB min  
**Input Bandwidth (-3 dB):** 420 kHz min  
**Input Impedance**  
**Resistance Between any Two AI-Terminals:** 200 kOhm  
**Input Bias Current:** 10 nA  
**Input Noise**  
**RMS:** 1.2 LSB  
**Peak-to-Peak:** 7 LSB  
**Crosstalk:** -80 dB  
**Settling Time [to 2 LSBs]**  
**10 V Step:** 25 µs  
**20 V Step:** 35 µs  
**No Missing Codes:** 15 bits guaranteed  
**DNL:** ±2 LSB max  
**INL:** ±6 LSB max

#### Digital I/O Lines

**Channels:** 8 digital I/O, programmable as a single port, or as individual lines  
**Power-Up Mode:** Inputs pulled low  
**Connector:** DB-9 female  
**Programmable Input Scanning Modes**  
**Asynchronous:** Under program control at any time relative to analog scanning  
**Synchronous:** Data captured synchronously with the analog channels  
**Input Levels**  
**Low:** 0 to +0.8 V  
**High:** +2.0 V to +5.0 V  
**Input Voltage Range without Damage:** -0.6 V to +5.6 V max  
**Input Pull-Down Resistor:** 10 kOhm  
**Output Voltage Range:** 0 to +3 V (may be externally pulled up to +5.6 V without damage)  
**Output Resistance:** 40 Ohm  
**Output Levels:** (See 6000 Series Digital Output graph above)  
**Sampling:** 1 MHz max continuous  
**Output Timing:** Outputs are always written asynchronously

#### Counters

**Channels:** Up to 4 independent  
**Resolution:** 32-bit  
**Input Frequency:** 20 MHz max  
**Input Characteristics:** 10 kOhm pulldown  
**Trigger Level:** TTL  
**Minimum Pulse Width:** 25 ns high, 25 ns low  
**Programmable Modes:** Counter, encoder  
**Encoder Resolution:** x1 (default), x2, and x4

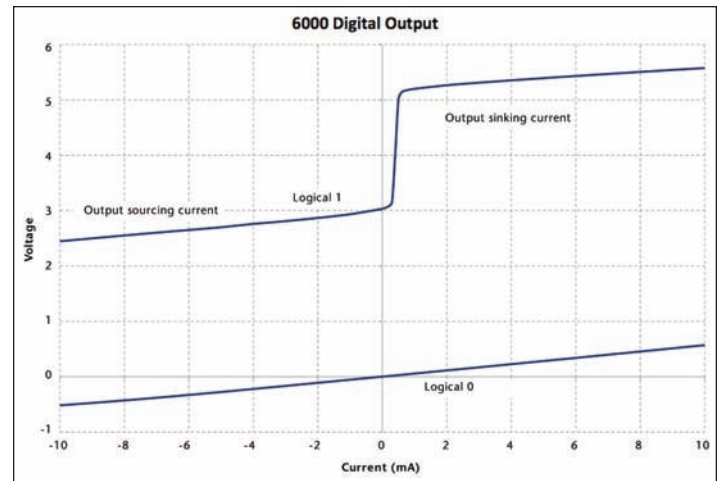

**Encoder Sources:** There are 3 encoder sources (A, B, and Z) that be assigned to any digital pin x

**Counter Source:** Internal clock, timer 1, timer 2, and digital pin x; one source can be used in multiple counters

**Counter Mode Options:** Totalize, clear on read, rollover, stop at the top, increment, decrement, rising edge, falling edge

**Counter Gate Options:** Unused, internal clock, timer 1, timer 2, and digital pin x; one gate can be used in multiple counters

#### Power

**Power Consumption:** 5.5 W typ, 6 W max  
**Power Jack:** Barrel type, 5.5 mm O.D.; 2.1 mm I.D.

#### Physical Characteristics

**Weight:** 1.36 Kg (3 lb)  
**Dimensions:** 276.9 mm W x 169.8 mm D x 30.5 mm H (10.9" x 6.685" x 1.2")

#### Environmental

The MCC 6220 is intended for indoor use only but may be used outdoors if installed in a suitable enclosure.

**Operating Temperature:** -40 to 50 °C

**Storage Temperature:** -40 to 75 °C

**Ingress Protection:** IP 40

**Operating Humidity:** 10 to 90% RH, noncondensing

**Storage Humidity:** 5 to 95% RH, noncondensing

**Maximum Altitude:** 2,000 m (6,562 ft.)

**Pollution Degree:** 2

#### Calibration

**Calibration Interval:** 1 year; contact factory for information regarding calibration service.

**Note:** The above calibration information pertains to hardware calibration, not to be confused with "user" or "software" calibration. When performing a "user" calibration via Encore (or other software) keep in mind that sample rate affects both gain and offset of the hardware, and therefore any "user" calibration should be performed at the same sample rate that is intended for measurements.

# 6220

## Ordering Information



### Ordering Information

Description	Part No.
12-channel, 16-bit resolution, Ethernet-based voltage measurement module, with included <i>Out-of-the-Box</i> Encore software	6220

#### Accessories & Cables

Universal power supply, 24 VDC @ 0.8 A (max); requires additional cable, CA-1 (US) or CA-216 (European)	TR-60U
Required cable for use with TR-60U; 120 V US version	CA-1
Required cable for use with TR-60U; 220 V European version	CA-216
RJ12 shielded cable, 6 conductor, SYNC, 0.3 m (1 ft.) <sup>1</sup>	CA-74-1
Ethernet crossover cables, 2.133 m (7 ft.) <sup>2,3</sup>	CA-192-7C
Ethernet patch cable, 0.457 m (1.5 ft.) <sup>2</sup>	CA-242
Ethernet patch cable, 2.133 m (7 ft.) <sup>2</sup>	CA-242-7
Stacking plate kit	190658A-01
Handle kit	HA-210-5-BK

1 Up to nine units can be synchronized. The total combined length of the SYNC cables is not to exceed 2.438 m (8 ft.).

2 Ethernet cable length must be <3 m (9.8 ft.) in order for the system to be CE Compliant.

3 Ethernet crossover cables should only be used for direct network connections. In particular, attempting to connect a device to a Hub using a crossover cable may prevent that network link from functioning. Some modern routers have become an exception by including logic to detect the crossover cable and allow the network link to function.



## Features

- 12 thermocouple inputs
- 24-bit ADC
- $\pm 80$  mV input range
- Simultaneous sampling
- Eight digital I/O
- Screw-terminal connectors
- Multiple trigger modes
- Ethernet interface to PC
- Expandable using multiple 6000 Series modules

## Software

- Includes Encore interactive measurement software for *Out-of-the-Box* setup, acquisition, display, logging, analysis, and reporting
- Advanced feature set with no programming required
- Drag-and-drop functionality
- Easy-to-use set-up wizards
- Ability to drag data directly to Excel®
- Included data analysis tools
- Playback mode
- Sophisticated test report capability
- Incorporate multiple 6000 Series devices into one application
- Supported Windows® Operating Systems: Windows 7 (32-bit or 64-bit), Windows Vista (32-bit or 64-bit), Windows XP SP2 (32-bit), Windows 2000 SP4

## Overview

The 6222 is a 12-channel thermocouple input module. It features 24-bit ADCs for highly accurate temperature measurements. The 6222 is part of the 6000 Series of instrument class, Ethernet-based data acquisition modules. Modules include powerful and easy-to-use Encore Interactive Measurement Software. Encore couples ease-of-use with advanced functionality including custom data displays, powerful analysis, and detailed reporting capabilities. 6000 Series modules feature integrated signal conditioning and a modular design that allows for system expansion. Because they use an Ethernet connection, modules can be connected directly to a PC or used in remote configurations utilizing multiple modules.



The 6222 with Encore software is a portable, thermocouple measurement solution

Feature	6000 Series Module Overview				
	6220	6222	6224	6230	6231
Analog input type	voltage	thermocouple	strain gage/bridge	voltage	voltage
Analog inputs	12	12	12	12	12
Digital I/O	8	8	8	8	8
Resolution	16 bit	24 bit	24 bit	24 bit	24 bit
Sample rate	100 kHz per channel	2 Hz	50 kHz per channel	50 kHz per channel	50 kHz per channel
Voltage input range	$\pm 10$ V	$\pm 80$ mV	$\pm 25$ mV/V	$\pm 10$ V	$\pm 60$ V
Connector type	BNC	screw-terminal	RJ50	screw-terminal	screw-terminal
Ch-to-ch isolation	—	—	—	Yes	Yes

## Analog Inputs

The 6222 is equipped with 12 thermocouple input channels. Inputs are also equipped with a  $\pm 80$  mV range. Each analog input provides 24-bit resolution with a 2 S/s sample rate per channel. All inputs are sampled simultaneously.

## Digital I/O

The 6222 includes eight digital I/O lines. All eight lines are accessible via a 9-pin female DSUB connector located on the rear panel of the unit. Each digital I/O bit can be programmed individually to be either an input or an output.

## Counters

There are four 32-bit counters built into each 6000 Series module. They are accessed through the 9-pin female DSUB connector located on the rear of the unit. Each counter has a maximum 20 MHz input frequency and can be used in counter or encoder (A, B, and Z) modes.

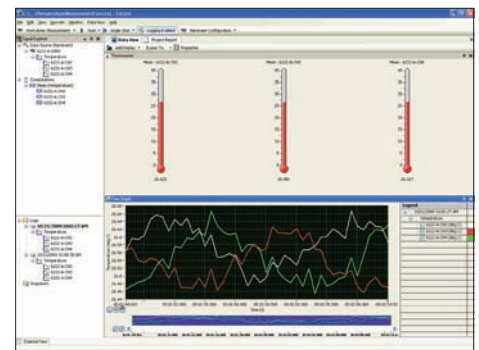

With Encore software you can display temperature and other channel data using meters, gauges, tanks and graphs

## Triggering

A variety of trigger modes are supported by the 6222. A wide selection of programmable analog and digital trigger modes are available for starting an acquisition. All trigger modes, along with the number of scans and the sample rate for pre- and post-trigger data, are software programmable prior to the start of a scan sequence.

# 6222

## General Information

### 6222 System Examples

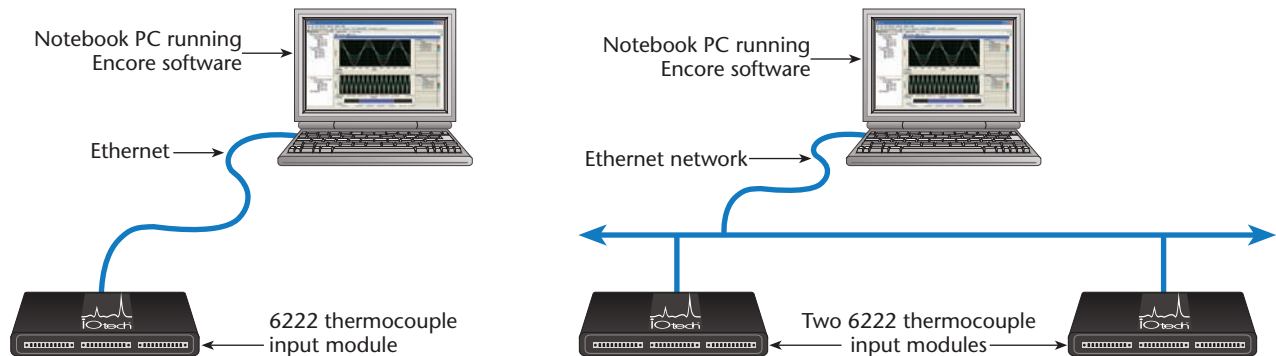

### System Power Connection

The 6222 and other 6000 Series modules offer the flexibility to be powered either directly from a 19 V to 30 VDC source, or via the included TR-60U AC power adapter.

### Ethernet Features

The 6000 Series transfers acquired data to the PC via 10/100BaseT Ethernet, allowing a continuous stream of data to be collected and stored in a PC's memory or hard drive. The most common and highest-performance connection is with dedicated, point-to-point Ethernet link between the PC and the 6222. With an enterprise-wide Ethernet network connection, any number of 6000 Series modules can be connected to the network.

### Multi-Unit Synchronization

Multiple 6000 Series modules can be synchronized via the rear-panel SYNC ports on each unit. After connecting each module to an Ethernet port, simply connect multiple 6000 Series modules together using SYNC cables (CA-74-1). Encore software provides the capability of setting one of the 6000 Series modules as the master and the others as slaves. The sampled data phase relationship among channels between multiple devices is dependent on the "Channel SYNC Skew" specification for each device.

### 6222 Block Diagram

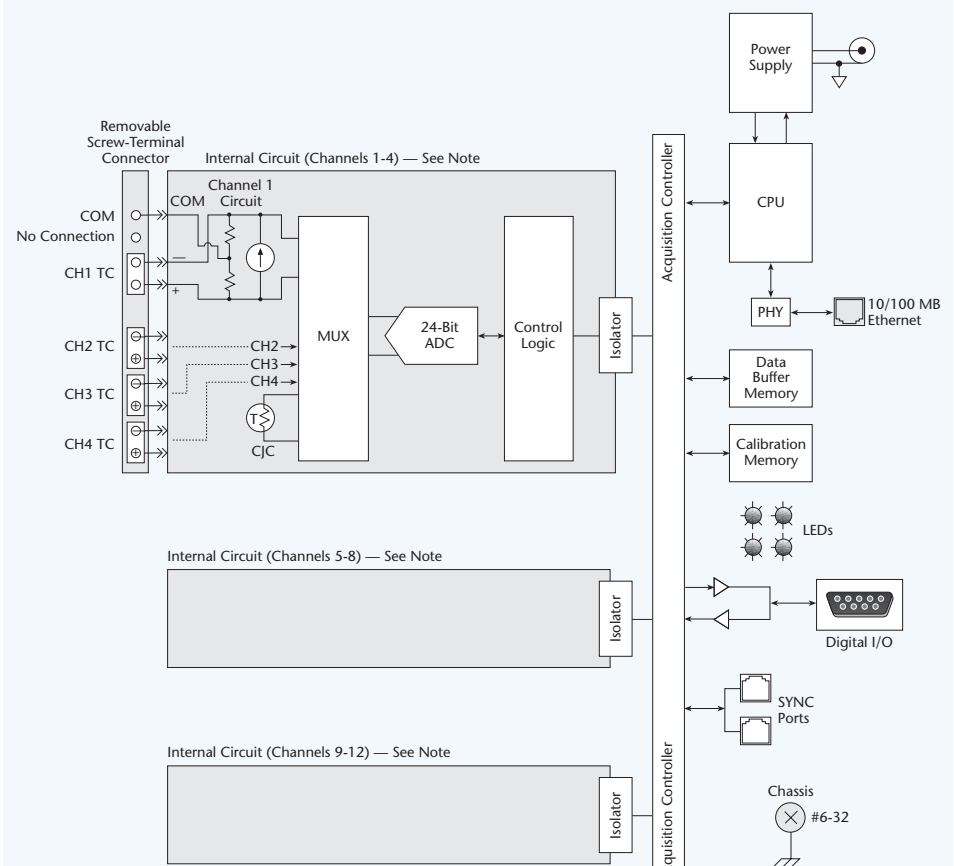

Note: Circuits for channel group 5 through 8 and group 9 through 12 look like that of the first group; for which only one channel is illustrated. Each four-channel circuit has one 24-bit ADC and one CJC.

# 6222

## Specifications

### Specifications

The following specifications are typical for the temperature range -40 to 50 °C unless otherwise noted.

#### Input Characteristics

**Number of Channels:** 12 thermocouple channels; 3 internal cold-junction compensation channels

**ADC Resolution:** 24 bits

**Type of ADC:** Delta-Sigma

**Voltage Measurement Range:** ±80 mV

**Common-Mode Range**

Channel-to-COM: ±1.5 V

Common-to-Earth Ground: ±250 V

**Common-Mode Rejection Ratio (0 to 60 Hz)**

Channel-to-COM: 95 dB

Common-to-Earth Ground: >170 dB

**Temperature Measurement Ranges:** Works over ranges defined by NIST for J, K, R, S, T, N, E, and B thermocouple types

**Cold-Junction Compensation Accuracy<sup>1</sup>**

0 to 50 °C: 0.6 °C (1.1 °F) typ, 1.3 °C (2.3 °F) max

-40 to 50 °C: 1.7 °C (3.1 °F) max

**Data Rate (fs):** 2 S/s

**Input Bandwidth (-3 dB):** 15 Hz

**Noise Rejection:** 85 dB min at 50/60 Hz

**Overvoltage Protection:** ±30 V between any input and common

**Differential Input Impedance:** 20 MOhm

**Input Current:** 50 nA

**Input Noise:** 1 μVrms

**Gain Error<sup>1</sup>:** 0.05% max at 25 °C, 0.06% typ at -40 to 50 °C, 0.1% max at -40 to 50 °C

**Offset Error<sup>1</sup>:** 15 μV typ, 20 μV max

**Gain Error from Source Impedance:** 0.05 ppm per Ohm source impedance due to input impedance

**Offset Error from Source Impedance:** 0.05 μV typ, 0.07 μV max per Ohm source impedance due to input current

#### Power

**Power Consumption:** 4.1 W max

**Power Jack:** Barrel type, 5.5 mm O.D.; 2.1 mm I.D.

#### Physical Characteristics

**Weight:** 1.22 Kg (2.7 lb)

**Dimensions:** 276.9 mm W x 169.8 mm D x 30.5 mm H (10.9" W x 6.685" D x 1.2"H)

**Removable Screw-Terminal Blocks:** 3 blocks, 4 channels per block, 10 terminals per block

**Screw-Terminal Wiring:** 12 to 24 AWG wire with 10mm (0.39 in.) section of insulation stripped from connection end

**Torque for Screw Terminals:** 0.5 to 0.6 N • m (4.4 to 5.3 lb • in.)

**Ferrules:** 0.25 mm to 2.5 mm (optional, not supplied)

#### Digital I/O

**Channels:** 8 Digital I/O, programmable as a single port, or as individual lines:

**Power-Up Mode:** Inputs pulled low

**Connector:** DB-9 female (figure)

**Programmable Input Scanning Modes**

**Asynchronous:** Under program control at any time relative to analog scanning.

**Synchronous:** Data captured synchronously with the analog channels.

**Input Levels**

**Low:** 0 to +0.8 V

**High:** +2.0 V to +5.0 V

**Input Voltage Range without Damage:** -0.6 V to +5.6 V max

**Input Pull-Down Resistor:** 10 kOhm

**Output Voltage Range:** 0 to +3.0 V

(may be externally pulled up to 5.6 V without damage)

**Output Resistance:** 40 Ohm

**Output Levels:** (See 6000 Series Digital Output graph above)

**Sampling:** 1 MHz max continuous

**Output Timing:** Outputs are always written asynchronously

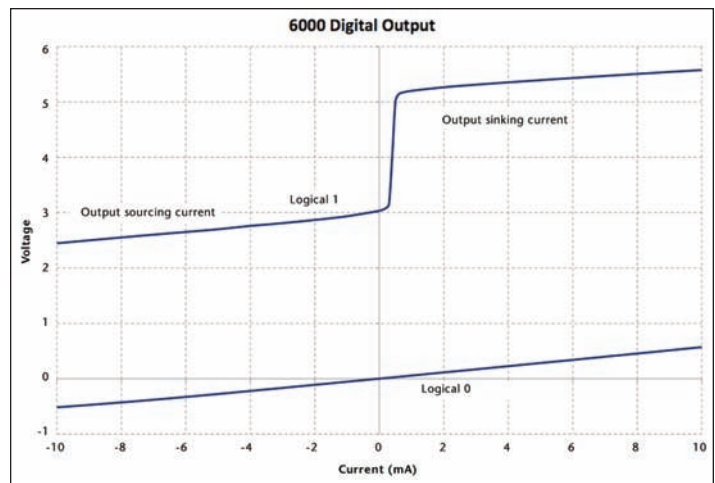

#### Counters

**Channels:** Up to 4 independent

**Resolution:** 32-bit

**Input Frequency:** 20 MHz max

**Input Characteristics:** 10 kOhm pulldown

**Trigger Level:** TTL

**Minimum Pulse Width:** 25 ns high, 25 ns low

**Programmable Modes:** Counter, encoder

**Encoder Resolution:** x1 (default), x2, and x4

**Encoder Sources:** There are 3 encoder sources (A, B, and Z) that be assigned to any digital pin x

**Counter Source:** Internal clock, timer 1, timer 2, and digital pin x; one source can be used in multiple counters

**Counter Mode Options:** Totalize, clear on read, rollover, stop at the top, increment, decrement, rising edge, falling edge

**Counter Gate Options:** Unused, internal clock, timer 1, timer 2, and digital pin x; one gate can be used in multiple counters

#### Safety

##### Safety Voltages

Only connect voltages that are within these limits.

**Channel-to-COM:** ±30 V max

##### Isolation Voltages

**Channel-to-Channel**

**Within each Four-Channel Internal Module:** No isolation between channels

**Between each Four-Channel Internal Module:** 250 V isolation

**Note:** There is no isolation between channels 1, 2, 3, and 4; no isolation between channels 5, 6, 7, and 8; and no isolation between channels 9, 10, 11, and 12.

**Channel-to-Earth Ground Continuous:** 250 Vrms, Measurement Category II

**Note:** Measurement Category II is for measurements performed on circuits directly connected to the electrical distribution system. This category refers to local-level electrical distribution, such as that provided by a standard wall outlet (for example, 115 V for U.S. or 230 V for Europe). Do not connect to signals or use for measurements within Measurement Categories III or IV.

1 Accuracy specifications are only valid when using provided connectors and properly installed backshells.

# 6222

## Specifications & Ordering Information

### Environmental

The 6222 is intended for indoor use only but may be used outdoors if installed in a suitable enclosure.

**Operating Temperature:** -40 to 50 °C

**Storage Temperature:** -40 to 85 °C

**Ingress Protection:** IP 40

**Operating Humidity:** 10 to 90% RH, noncondensing

**Storage Humidity:** 5 to 95% RH, noncondensing

**Maximum Altitude:** 2,000 m (6,562 ft.)

**Pollution Degree:** 2

### Calibration

**Calibration Interval:** 1 year; contact factory for information regarding calibration service.

**Note:** The above calibration information pertains to hardware calibration, not to be confused with “user” or “software” calibration. When performing a “user” calibration via Encore (or other software) keep in mind that sample rate affects both gain and offset of the hardware, and therefore any “user” calibration should be performed at the same sample rate that is intended for measurements.

### Ordering Information

#### Description

12-channel, 24-bit ADC, Ethernet-based thermocouple input module, with included *Out-of-the-Box* Encore software

#### Part No.

6222

#### Accessories & Cables

Universal power supply, 24 VDC @ 0.8 A (max); requires additional cable,

CA-1 (US) or CA-216 (European)

Required cable for use with TR-60U; 120 V US version

Required cable for use with TR-60U; 220 V European version

RJ12 shielded cable, 6 conductor, SYNC, 0.3 m (1 ft.)<sup>1</sup>

Ethernet crossover cables, 2.133 m (7 ft.)<sup>2,3</sup>

Ethernet patch cable, 0.457 m (1.5 ft.)<sup>2</sup>

Ethernet patch cable, 2.133 m (7 ft.)<sup>2</sup>

Backshell connector kit

Stacking plate kit

Handle kit

TR-60U

CA-1

CA-216

CA-74-1

CA-192-7C

CA-242

CA-242-7

CN-271

190658A-01

HA-210-5-BK

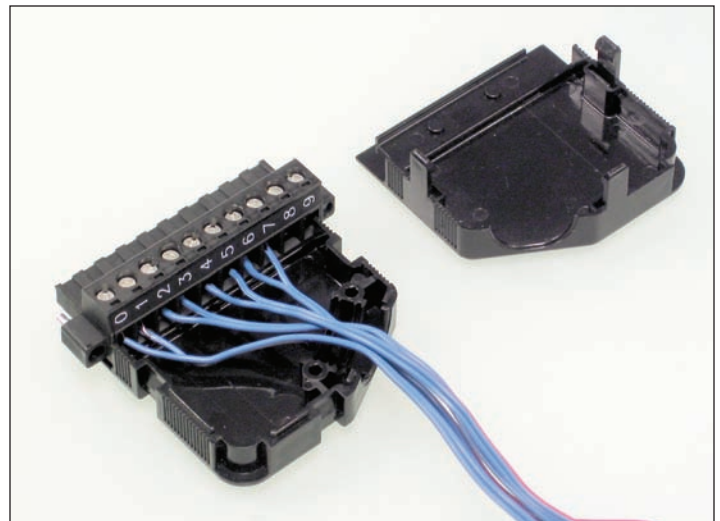
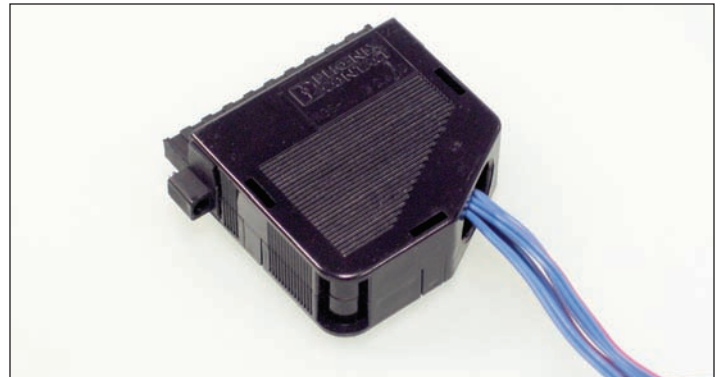

*CN-271 connectors and backshells are included with the 6222 and provide internal screw-terminal connectors for wiring thermocouples*

<sup>1</sup> Up to nine units can be synchronized. The total combined length of the SYNC cables is not to exceed 2.438 m (8 ft.).

<sup>2</sup> Ethernet cable length must be <3 m (9.8 ft.) in order for the system to be CE Compliant.

<sup>3</sup> An Ethernet crossover cable must be used when connecting a 6000 Series device directly to the host PC.



## Features

- 12 strain gage inputs
- 24-bit/delta-sigma ADC per channel
- 50 kHz per channel sample rate
- User programmable excitation
- Simultaneous sampling
- Remote sensing
- Shunt calibration
- Eight digital I/O
- Multiple trigger modes
- Compact, portable design
- Expandable using multiple 6000 Series modules

## Software

- Includes Encore interactive measurement software for *Out-of-the-Box* setup, acquisition, display, logging, analysis, and reporting
- Advanced feature set with no programming required
- True drag-and-drop functionality
- Easy-to-use set-up wizards
- Drag data directly to Excel®
- Included data analysis tools
- Playback mode
- Sophisticated test report capability
- Incorporate multiple 6000 Series devices into one application
- Supported Windows® Operating Systems: Windows 7 (32-bit or 64-bit), Windows Vista (32-bit or 64-bit), Windows XP SP2 (32-bit), Windows 2000 SP4





## Overview

The 6000 Series combines accurate, instrument class, Ethernet-based modules with powerful, easy-to-use software. It is a major advancement in ease of use and functionality. 6000 Series modules feature integrated signal conditioning and a modular design that allows for system expansion. Because they use an Ethernet connection, modules can be connected directly to a PC or used in remote configurations utilizing multiple modules. Modules are offered for voltage or direct strain inputs.

Each 6000 Series module includes Encore interactive measurement software. Encore couples ease-of-use with advanced functionality including custom data displays, powerful analysis, and detailed reporting capabilities.



The 6224 with Encore software is a portable, strain gage measurement solution

6000 Series Module Overview					
	6220	6222	6224	6230	6231
Feature					
Analog input type	voltage	thermocouple	strain gage/bridge	voltage	voltage
Analog inputs	12	12	12	12	12
Digital I/O	8	8	8	8	8
Resolution	16 bit	24 bit	24 bit	24 bit	24 bit
Sample rate	100 kHz per channel	2 Hz	50 kHz per channel	50 kHz per channel	50 kHz per channel
Voltage input range	±10 V	±80 mV	±25 mV/V	±10 V	±60 V
Connector type	BNC	screw-terminal	RJ50	screw-terminal	screw-terminal
Ch-to-ch isolation	—	—	—	Yes	Yes

## Direct Strain Gage Inputs

The 6224 is equipped with 12 analog input channels capable of measuring full-, half-, or quarter-bridge sensors. Each of the 12 analog channels has its own 24-bit ADC and input amplifier allowing all 12 channels to be sampled simultaneously. The 6224 also includes anti-aliasing filters. All strain input signals are attached via 12 RJ50 connectors mounted on the front of the module.

The 6224 features direct strain gage inputs. Half or full-bridge sensors are supported. Quarter-bridge sensors are also supported using an external resistor. The 6224 is also 100% software programmable. Excitation, auto-zero, and shunt calibration are each adjusted in software without relying on manually adjusted trimpots which can cause increased error and drift. Excitation is provided by the 6224 and can be software selected for 2.5 V, 3.3 V, 5 V,

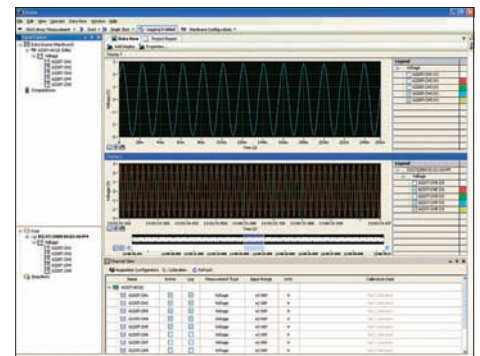

Encore provides real-time viewing and analysis of data along with built-in test report capabilities

or 10 V. For excitation values beyond those listed, an external excitation source may be used. Connectors are provided on the front of the unit for excitation source wiring.

# 6224

## General Information

6224 Block Diagram

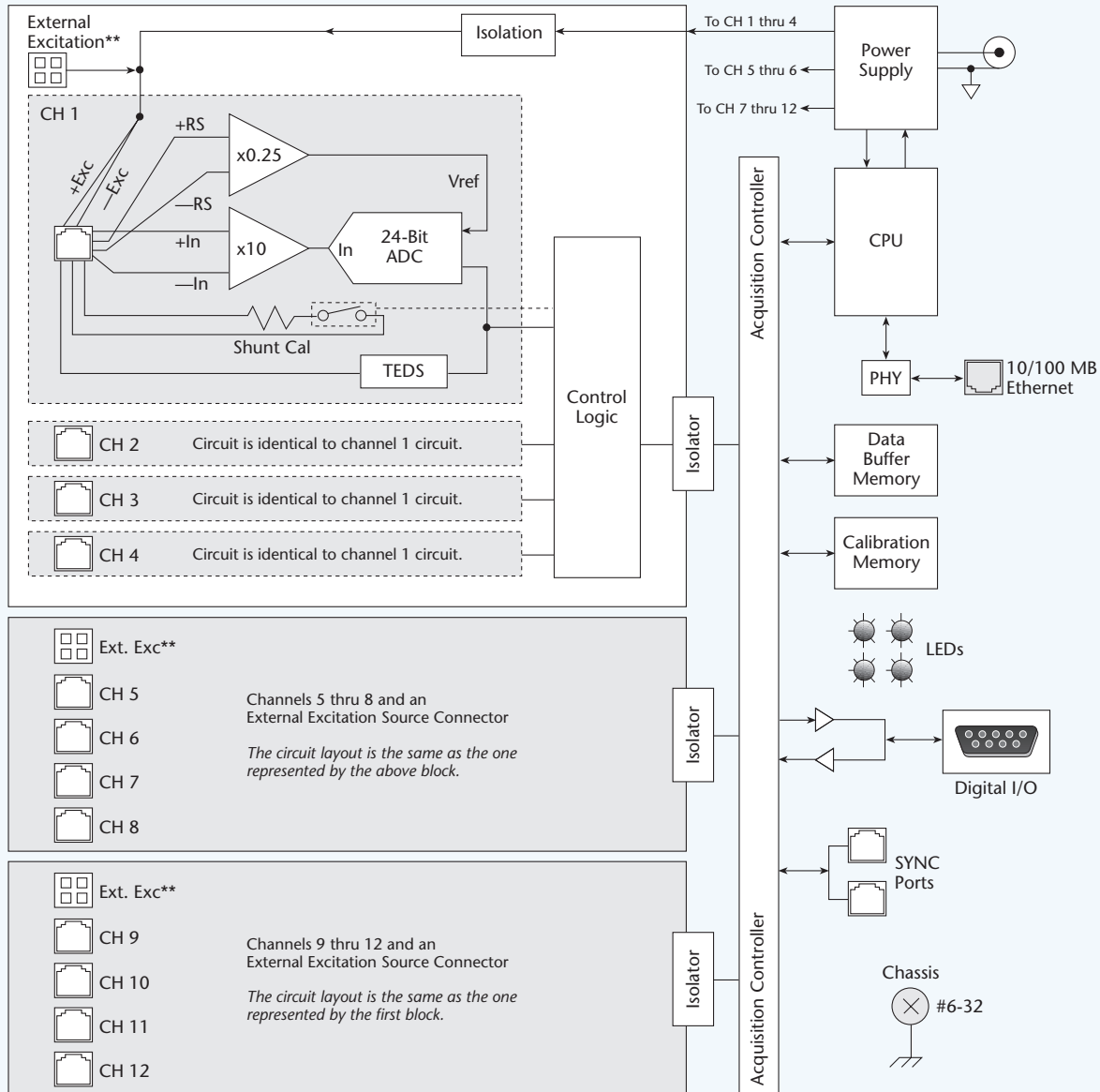

\*\* There are three External Excitation Voltage Source Connectors.  
 The first serves channels 1 thru 4.  
 The second serves channels 5 thru 8.  
 The third serves channels 9 thru 12.

### Shunt Calibration

Shunt calibration enables each channel to be put into a known imbalance condition to set or verify channel calibration. Shunt-cal allows a full scale gain to be set without physically loading the bridge to capacity.

### Remote Sensing

Remote sensing automatically and continuously corrects for voltage drop errors in excitation leads.

# 6224

## General Information

### 6224 System Examples

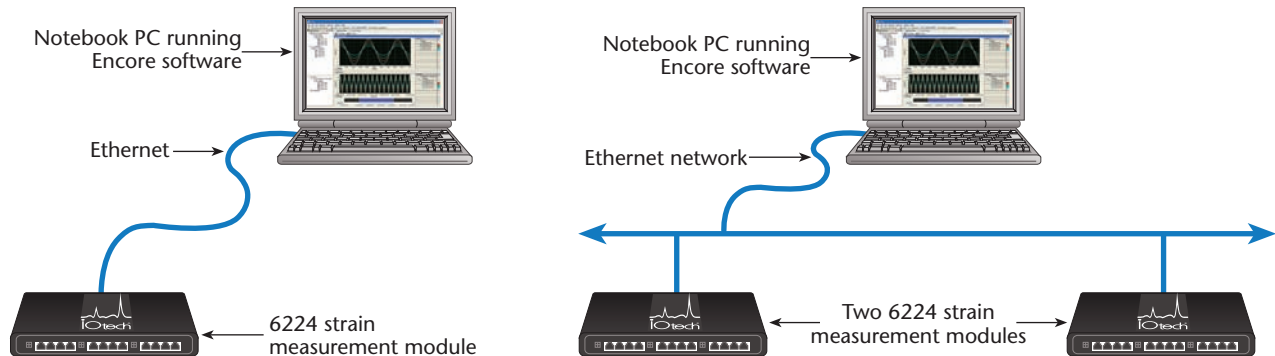

The CN-268 is an RJ50 to 12-pin screw terminal break-out connector module. The CN-269 and CN-270 offer internal bridge completion resistors for quarter-bridge configurations.

### Signal Connections

The 12 strain gage inputs on the 6224 are accessed via 12 RJ50 front panel connectors. 12 user specified connector modules are included with the 6224.

#### Full- and Half-Bridge Configurations

The 6224 supports full- and half-bridge configurations directly. Users can connect to the RJ50 front panel connectors or use the CN-268 12-pin screw terminal break-out connector module.

#### Quarter-Bridge Configurations

For quarter-bridge configurations the CN-269 and CN-270 feature 120 Ohm and 350 Ohm internal bridge completion resistors respectively. The CN-269 and CN-270 feature an RJ50 female connector one end and screw terminals on the other. One module is required for each channel.

### Digital I/O

The 6224 includes eight digital I/O lines. All eight lines are accessible via a 9-pin female DSUB connector located on the rear panel of the unit. Each digital I/O bit can be programmed individually to be either an input or an output.

### Counters

There are four 32-bit counters built into each 6000 Series module. They are accessed through the 9-pin female DSUB connector located on the rear of the unit. Each counter has a maximum 20 MHz input frequency and can be used in counter or encoder (A, B, and Z) modes.

### Triggering

A variety of trigger modes are supported by the 6224. A wide selection of programmable analog and digital trigger modes are available for starting an acquisition. All trigger modes, along with the number of scans and the sample rate for pre- and post-trigger data, are software programmable prior to the start of a scan sequence.

### System Power Connection

The 6224 and other 6000 Series modules offer the flexibility to be powered either directly from a 19 V to 30 VDC source, or via the included TR-60U AC power adapter.

### Ethernet Features

The 6000 Series transfers acquired data to the PC via 10/100BaseT Ethernet, allowing a continuous stream of data to be collected and stored in a PC's memory or hard drive. The most common and highest-performance connection is with dedicated, point-to-point Ethernet link between the PC and the 6224. With an enterprise-wide Ethernet network connection, any number of 6000 Series modules can be connected to the network.

### Multi-Unit Synchronization

Multiple 6000 Series modules can be synchronized via the rear-panel SYNC ports on each unit. After connecting each module to an Ethernet port, simply connect multiple 6000 Series modules together using SYNC cables (CA-74-1). Encore software provides the capability of setting one of the 6000 Series modules as the master and the others as slaves. The sampled data phase relationship among channels between multiple devices is dependent on the "Channel SYNC Skew" specification for each device.

# 6224

## Specifications

### Specifications

The following specifications are typical for the temperature range -40 to 50 °C unless otherwise noted.

#### Input Characteristics

**Number of Analog Channels:** 12  
**Bridge Completion**  
 Full and Half: Internal  
 Quarter: External  
**ADC Resolution:** 24 bits  
**Type of ADC:** Delta-sigma (with analog pre-filtering)  
**Sampling Mode:** Simultaneous  
**Data Rates (fs):** (50 kS/s)/n, n = 1, 2, ... 31.  
**Multiple Device, Channel SYNC Skew:** 1 sample period  
**Single Device, Channel-to-Channel Matching (Calibrated):** 350 nS (max)  
**Master Timebase (Internal)**  
 Frequency: 12.8 MHz  
 Accuracy: ±100 ppm max  
**Nominal Full-Scale Range:** ±25 mV/V  
**Scaling Coefficient:** 2.9802 nV/V per LSB  
**Overtolerance Protection Between any Two Terminals:** ±30 V

#### Accuracy

Error*	Percent of Reading	Offset
Calibrated max (-40 to 50 °C)	0.20%	0.0625 mV/V
Calibrated typ (25 °C, ±15 °C)	0.05%	0.0125 mV/V

\* Excluding offset null or shunt calibration.

**Gain Drift:** 10 ppm/°C max

#### Offset Drift

2.5 V Excitation: 0.6 µV/V per °C  
 3.3 V Excitation: 0.5 µV/V per °C  
 5 V Excitation: 0.3 µV/V per °C  
 10 V Excitation: 0.2 µV/V per °C

#### Channel-to-Channel Matching (Calibrated)

Input Signal Frequency ( $f_{in}$ )	Gain	
	Typical	Maximum
0 to 1 kHz	0.15%	0.3%
1 to 20 kHz	0.4%	1.1%

#### Phase Nonlinearity

0 to 1 kHz: <0.001°  
 0 to 20 kHz: ±0.1°

**Input Delay:** 4.8 µs + 38.4/f<sub>s</sub>

#### Passband

Frequency: 0.45 • f<sub>s</sub>  
 Flatness: 0.1 dB max

#### Stopband

Frequency: 0.55 • f<sub>s</sub>  
 Attenuation: 100 dB  
 Alias-Free Bandwidth: 0.45 • f<sub>s</sub>

#### Oversample Rate: 64 • f<sub>s</sub>

**Attenuation at Oversample Rate<sup>1</sup>**  
 50 kS/s: 90 dB @ 3.2 MHz  
 10 kS/s: 60 dB @ 640 kHz

#### Common-Mode Voltage

All Signals to Earth Ground: ±60 VDC  
**Common-Mode Rejection Ratio (CMRR)**  
 Relative to Earth Ground<sup>2</sup>: -140 dB @ 0 to 60 Hz  
 Relative to EX-: -85 dB @ 0 to 1 kHz

<sup>1</sup> Rejection by analog prefilter of signal frequencies at oversample rate.

<sup>2</sup> Measured with a balanced cable. Shielded cables may be significantly unbalanced.

#### Input Noise

Excitation Voltage	Density (nV/V <sub>rms</sub> per √1 Hz)	Total (50 kS/s) (µV/V <sub>rms</sub> )	0 to 1 kHz (nV/V <sub>rms</sub> )
2.5 V	8	1.3	250
3.3 V	6	1.0	190
5.0 V	4	0.6	130
10.0 V	2	0.3	65

**Spurious-Free Dynamic Range (SFDR):** 106 dB, (1kHz, -60 dBFS)

**Total Harmonic Distortion (Fundamental @ -20 dBFS)**

1 kHz: -100 dB

8 kHz: -90 dB

**Excitation Noise:** 0.1 mV/V<sub>rms</sub>

#### Crosstalk

1 kHz: -110 dB

10 kHz: -100 dB

#### Shunt Calibration

Resistance: 100 kOhm

#### Resistor Accuracy

25 °C: ±110 Ohm

-40 to 50 °C: ±200 Ohm

#### Excitation

Internal Voltage: 2.5 V, 3.3 V, 5.0 V, 10.0 V

Internal Power: 450 mW max

External Voltage: 2 V to 10 V

#### Digital I/O

**Channels:** 8 digital I/O, programmable as single port, or as individual lines

**Power-Up Mode:** Inputs pulled low

**Connector:** DB-9 female

#### Programmable Input Scanning Modes

**Asynchronous:** Under program control at any time relative to analog scanning

**Synchronous:** Data captured synchronously with the analog channels

#### Input Levels

Low: 0 to +0.8 V

High: +2.0 V to +5.0 V

**Input Voltage Range without Damage:** -0.6 V to +5.6 V max

**Input Pull-Down Resistor:** 10 kOhm

**Output Voltage Range:** 0 to +3 V, (may be externally pulled up to 5.6 V without damage)

**Output Resistance:** 40 Ohm

**Output Levels:** (See 6000 Series Digital Output graph below)

**Sampling:** 1 MHz max continuous

**Output Timing:** Outputs are always written asynchronously

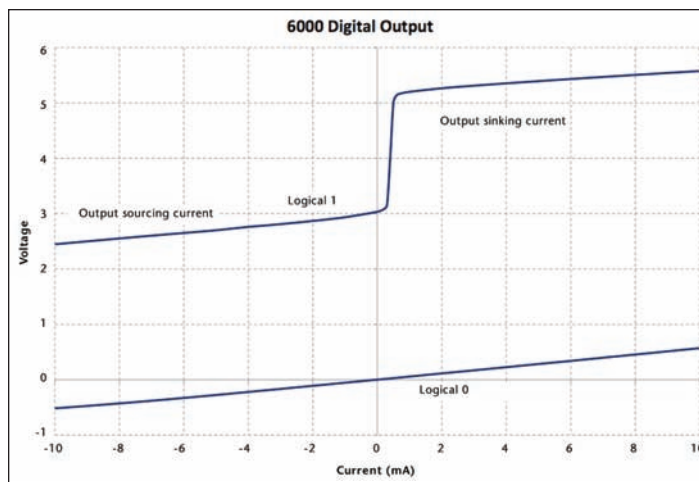

# 6224

## Specifications and Ordering Information



### Counters

**Channels:** Up to 4 independent  
**Resolution:** 32-bit  
**Input Frequency:** 20 MHz max  
**Input Characteristics:** 10 kOhm pulldown  
**Trigger Level:** TTL  
**Minimum Pulse Width:** 25 ns high, 25 ns low  
**Programmable Modes:** Counter, encoder  
**Encoder Resolution:** x1 (default), x2, and x4  
**Encoder Sources:** There are 3 encoder sources (A, B, and Z) that be assigned to any digital pin x  
**Counter Source:** Internal clock, timer 1, timer 2, and digital pin x; one source can be used in multiple counters  
**Counter Mode Options:** Totalize, clear on read, rollover, stop at the top, increment, decrement, rising edge, falling edge  
**Counter Gate Options:** Unused, internal clock, timer 1, timer 2, and digital pin x; one gate can be used in multiple counters

### Power

**Power Consumption:** 6.3 W typ, 6.6 W max  
**Power Jack:** Barrel type, 5.5 mm O.D.; 2.1 mm I.D.

### Physical Characteristics

**Weight:** 1.3 kg (2.88 lbs)  
**Dimensions:** 276.9 mm W x 169.8 mm D x 30.5 mm H (10.9" x 6.685" x 1.2")

### Environmental

6224 units are intended for indoor use only but may be used outdoors if installed in a suitable enclosure.  
**Operating Temperature:** -40 to 50 °C  
**Storage Temperature:** -40 to 75 °C  
**Ingress Protection:** IP 40  
**Operating Humidity:** 10 to 90% RH, noncondensing  
**Storage Humidity:** 5 to 95% RH, noncondensing  
**Maximum Altitude:** 2,000 m (6,562 ft.)  
**Pollution Degree:** 2

### Calibration

**Calibration Interval:** 1 year; contact factory for information regarding calibration service.

**Note:** The above calibration information pertains to hardware calibration, not to be confused with "user" or "software" calibration. When performing a "user" calibration via Encore (or other software) keep in mind that sample rate affects both gain and offset of the hardware, and therefore any "user" calibration should be performed at the same sample rate that is intended for measurements.

## Ordering Information

Description	Part No.
12-channel, 24-bit resolution, Ethernet-based strain measurement module, with included <i>Out-of-the-Box</i> Encore software	6224

### Accessories & Cables

Universal power supply, 24 VDC @ 0.8 A (max); requires additional cable,	
CA-1 (US) or CA-216 (European)	TR-60U
Required cable for use with TR-60U; 120 V US version	CA-1
Required cable for use with TR-60U; 220 V European version	CA-216
RJ12 shielded cable, 6 conductor, SYNC, 0.3 m (1 ft.) <sup>1</sup>	CA-74-1
RJ50, 12-pin screw-terminal connector, 4 pack	CN-268
RJ50, 120 Ohm quarter bridge connector, 4 pack	CN-269
RJ50, 350 Ohm quarter bridge connector, 4 pack	CN-270
RJ50 to RJ50 M/M, 1 m (3.28 ft.) cable, 4 pack	CA-272-01
Ethernet crossover cables, 2.133 m (7 ft.) <sup>2,3</sup>	CA-192-7C
Ethernet patch cable, 0.457 m (1.5 ft.) <sup>2</sup>	CA-242
Ethernet patch cable, 2.133 m (7 ft.) <sup>2</sup>	CA-242-7
Stacking plate kit	190658A-01
Handle kit	HA-210-5-BK

- 1 Up to nine units can be synchronized. The total combined length of the SYNC cables is not to exceed 2.438 m (8 ft.).
- 2 Ethernet cable length must be <3 m (9.8 ft.) in order for the system to be CE Compliant.
- 3 Ethernet crossover cables should only be used for direct network connections. In particular, attempting to connect a device to a Hub using a crossover cable may prevent that network link from functioning. Some modern routers have become an exception by including logic to detect the crossover cable and allow the network link to function.



# 6230 & 6231

## High-Speed, Isolated Voltage Input Modules



### Features

- 12 voltage inputs
- 24-bit ADC per channel, 50 kHz sample rate
- $\pm 10$  V (6230) or  $\pm 60$  V (6231) input range
- 250 V channel to channel isolation
- Simultaneous sampling
- Eight digital I/O
- Screw-terminal connectors
- Multiple trigger modes
- Ethernet-interface to PC
- Expandable using multiple 6000 Series modules







The 6230 and 6231 with Encore software are high-speed isolated voltage measurement solutions

### Software

- Includes Encore interactive measurement software for *Out-of-the-Box* setup, acquisition, display, logging, analysis, and reporting
- Advanced feature set with no programming required
- Drag-and-drop functionality
- Easy-to-use set-up wizards
- Ability to drag data directly to Excel®
- Included data analysis tools
- Playback mode
- Sophisticated test report capability
- Incorporate multiple 6000 Series devices into one application
- Supported Windows® Operating Systems: Windows 7 (32-bit or 64-bit), Windows Vista (32-bit or 64-bit), Windows XP SP2 (32-bit), Windows 2000 SP4

### Overview

The 6230 and 6231 are high-speed, isolated voltage input modules. The 6230 includes 12 voltage inputs with a  $\pm 10$  V range. The 6231 offers a  $\pm 60$  V range. Each module features a 24-bit ADC per channel and channel-to-channel isolation. The 6230 and 6231 are part of the 6000 Series of Ethernet-based data acquisition modules which feature integrated signal conditioning and a modular design that allows for system expansion. Because they use an Ethernet connection, modules can be connected directly to a PC or used in remote configurations utilizing multiple modules. Each 6000 Series module includes Encore interactive measurement software. Encore couples ease-of-use with advanced functionality including custom data displays, powerful analysis, and detailed reporting capabilities.

6000 Series Module Overview					
	6220	6222	6224	6230	6231
Feature					
Analog input type	voltage	thermocouple	strain gage/bridge	voltage	voltage
Analog inputs	12	12	12	12	12
Digital I/O	8	8	8	8	8
Resolution	16 bit	24 bit	24 bit	24 bit	24 bit
Sample rate	100 kHz per channel	2 Hz	50 kHz per channel	50 kHz per channel	50 kHz per channel
Voltage input range	$\pm 10$ V	$\pm 80$ mV	$\pm 25$ mV/V	$\pm 10$ V	$\pm 60$ V
Connector type	BNC	screw-terminal	RJ50	screw-terminal	screw-terminal
Ch-to-ch isolation	—	—	—	Yes	Yes

### Analog Inputs

The 6230 is equipped with 12 analog input channels with a  $\pm 10$  V range. The 6231 includes a  $\pm 60$  V range. Each analog input features a 24-bit ADC with a maximum 50 kHz sample rate per channel. All channels are sampled simultaneously. The 6230 and 6231 also include 250 Vrms channel-to-channel isolation for increased signal integrity and protection.

### Digital I/O

The 6230 and 6231 include eight digital I/O lines. All eight lines are accessible via a 9-pin female DSUB connector located on the rear panel of the unit. Each digital I/O bit can be programmed individually to be either an input or an output.

### Counters

There are four 32-bit counters built into each 6000 Series module. They are accessed through the 9-pin female DSUB connector located on the rear of the unit. Each counter has a maximum 20 MHz input

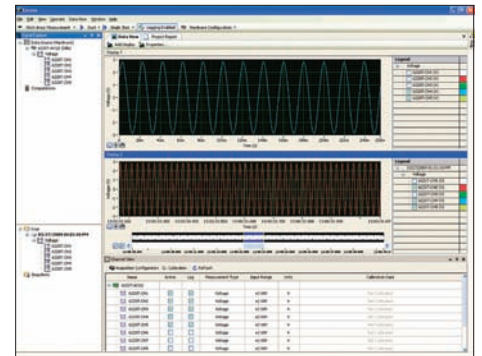

Encore provides real-time viewing and analysis of data along with built-in test report capabilities

frequency and can be used in counter or encoder (A, B, and Z) modes.

### Triggering

A variety of trigger modes are supported by the 6230 and 6231. A wide selection of programmable analog and digital trigger modes are available for starting an acquisition. All trigger modes, along

# 6230 & 6231

## General Information

### 6230/6231 System Examples

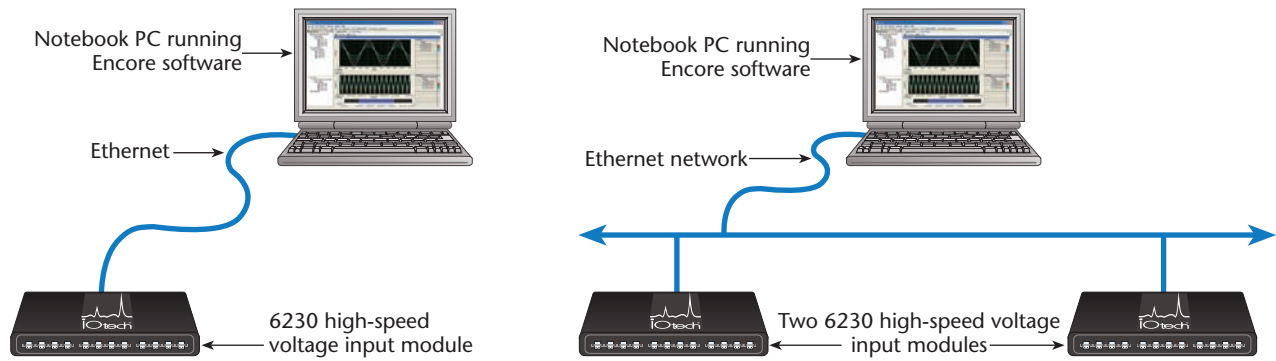

with the number of scans and the sample rate for pre- and post-trigger data, are software programmable prior to the start of a scan sequence.

### System Power Connection

The 6230 and 6231 offer the flexibility to be powered either directly from a 19 V to 30 VDC source, or via the included TR-60U AC power adapter.

### Ethernet Features

The 6000 Series transfers acquired data to the PC via 10/100BaseT Ethernet, allowing a continuous stream of data to be collected and stored in a PC's memory or hard drive. The most common and highest-performance connection is with dedicated, point-to-point Ethernet link between the PC and the 6230 and 6231. With an enterprise-wide Ethernet network connection, any number of 6000 Series modules can be connected to the network.

### Multi-Unit Synchronization

Multiple 6000 Series modules can be synchronized via the rear-panel SYNC ports on each unit. After connecting each module to an Ethernet port, simply connect multiple 6000 Series modules together using SYNC cables (CA-74-1). Encore software provides the capability of setting one of the 6000 Series modules as the master and the others as slaves. The sampled data phase relationship among channels between multiple devices is dependent on the "Channel SYNC Skew" specification for each device.

### 6230 and 6231 Block Diagram

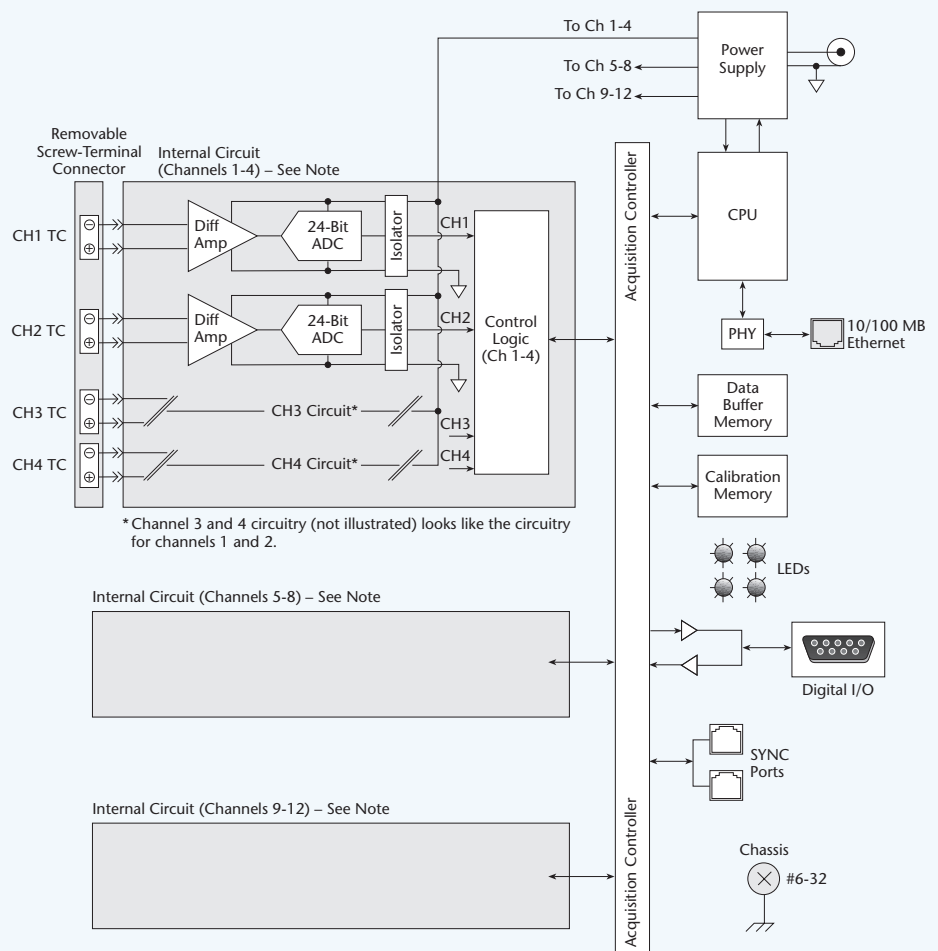

**Note:** The schematics for channel group 5 through 8 and group 9 through 12 look like that of the first group. Each channel has its own differential amplifier and ADC. All channels are electrically isolated.

# 6230 & 6231

## Specifications



### Specifications

The following specifications are typical for the temperature range -40 to 50 °C unless otherwise noted. The specifications apply to both the 6230 and 6231 except when otherwise noted.

#### Input Characteristics

Number of Analog Channels: 12  
 ADC Resolution: 24 bits  
 Type of ADC: Delta-Sigma (with analog pre-filtering)  
 Sampling Mode: Simultaneous  
 Data Rate Range (fs)  
 Minimum: 1.613 kS/s  
 Maximum: 50 kS/s  
 Data Rates (fs): (50 kS/s)/n, n = 1, 2, ...31  
 Multiple Device, Channel Sync Skew<sup>1</sup>: sample period  
 Single Device, Channel-to-Channel Matching (Calibrated)  
 6230: 208 nS (max)  
 6231: 125 nS (max)  
 Master Timebase (Internal)  
 Frequency: 12.8 MHz  
 Accuracy: ±100 ppm max

#### Operating Voltage Ranges

Measurement Voltage, AI+ to AI-			
Device	Nominal (V)	Typical (V)	Minimum (V)
6230	±10	±10.52	±10.3
6231	±60	±62.64	±61.5

Overvoltage Protection: ±100 V  
 Input Coupling: DC  
 Input Impedance (AI+ to AI-): 1 MOhm

#### Accuracy, 6230 (Typical Range: ±10.52V)

Measurement Conditions	Percent of Reading (Gain Error)	Offset Error
Calibrated max (-40 to 50 °C)	0.13%	±6.31 mV
Calibrated typ (25 °C, ±5 °C)	0.03%	±842 µV

#### Accuracy, 6231 (Typical range: ±62.64V)

Measurement Conditions	Percent of Reading (Gain Error)	Offset Error
Calibrated max (-40 to 50 °C)	0.13%	±31.3 mV
Calibrated typ (25 °C, ±5 °C)	0.03%	±5.01 mV

#### Input Noise

6230: 70 µVrms  
 6231: 320 µVrms

#### Stability

Gain Drift: ±5 ppm/°C

Offset Drift

6230: ±24 µV/°C

6231: ±150 µV/°C

Post Calibration Gain Match (Ch-to-Ch, 20 kHz): 0.22 dB max

Crosstalk (1 kHz): -130 dB

Phase Nonlinearity (f<sub>s</sub> = 50 kS/s): 0.11° max

#### Input Delay

6230: 38.4/f<sub>s</sub> + 3 µs

6231: 38.4/f<sub>s</sub> + 2.6 µs

#### Passband

Frequency: 0.453 · f<sub>s</sub>

Flatness (f<sub>s</sub> = 50 kS/s): ±100 mdB max

#### Stopband

Frequency: 0.547 · fs

Rejection: 100 dB

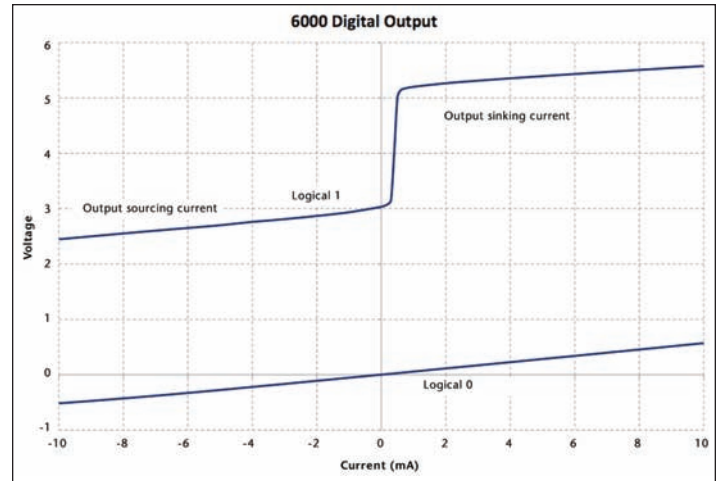

Alias-free bandwidth: 0.453 · fs  
 -3 dB prefilter bandwidth (fs = 50 kS/s): 24.56 kHz  
 CMRR (f<sub>in</sub> = 60 Hz)  
 6230: 126 dB  
 6231: 116 dB  
 SFDR (1 kHz, -60 dBFS): -128 dBFS  
 Total Harmonic Distortion (THD)  
 1 kHz, -1 dBFS: -99 dB  
 1 kHz, -20 dBFS: 105 dB

#### Digital I/O

Channels: 8 Digital I/O, programmable as a single port, or as individual lines

Power-Up Mode: Inputs pulled low

Connector: DB-9 female

Programmable Input Scanning Modes

Asynchronous: Under program control at any time relative to analog scanning.

Synchronous: Data captured synchronously with the analog channels.

#### Input Levels

Low: 0 to +0.8 V

High: +2.0 V to +5.0 V

Input Voltage Range without Damage: -0.6 V to +5.6 V max

Input Pull-Down Resistor: 10 kOhm

Output Voltage Range: 0 to +3.0 V

(may be externally pulled up to 5.6 V without damage)

Output Resistance: 40 Ohm

Output Levels: (see 6000 Series Digital Output graph above)

Sampling: 1 MHz max continuous

Output Timing: Outputs are always written asynchronously.

#### Counters

Channels: Up to 4 independent

Resolution: 32-bit

Input Frequency: 20 MHz max

Input Characteristics: 10 kOhm pulldown

Trigger Level: TTL

Minimum Pulse Width: 25 ns high, 25 ns low

Programmable Modes: Counter, encoder

Encoder Resolution: x1 (default), x2, and x4

Encoder Sources: There are 3 encoder sources (A, B, and Z) that be assigned to any digital pin x

Counter Source: Internal clock, timer 1, timer 2, and digital pin x; one source can be used in multiple counters

Counter Mode Options: Totalize, clear on read, rollover, stop at the top, increment, decrement, rising edge, falling edge

Counter Gate Options: Unused, internal clock, timer 1, timer 2, and digital pin x; one gate can be used in multiple counters

<sup>1</sup> Mclk is the master timebase.

# 6230 & 6231

## Ordering Information



### Power

**Power Consumption:** 5.5 W typ, 6 W max  
**Power Jack:** Barrel type, 5.5 mm O.D.; 2.1 mm I.D.

### Safety Voltages (Isolation)

**Channel-to-Earth Ground (Continuous):** 250 Vrms, Measurement Category II  
**Channel-to-Channel (Continuous):** 250 Vrms, Measurement Category II

### Physical Characteristics

**Weight:** 1.24 Kg (2.7 lb)  
**Dimensions:** 276.9mm W x 169.8mm D x 30.5mm H (10.9" W x 6.685" D x 1.2"H)  
**Screw-Terminal Wiring:** 16 to 28 AWG copper conductor wire with 7 mm (0.28 in.) of insulation stripped from the end  
**Torque for Screw Terminals:** 0.22 to 0.25 N • m (1.95 to 2.21 lb • in.)  
**Ferrules:** 0.25 mm<sup>2</sup> to 0.5 mm<sup>2</sup> (optional, not supplied)

### Environmental

The 6230 and 6231 are intended for indoor use, but may be used outdoors if installed in a suitable enclosure.  
**Operating Temperature:** -40 to 50 °C  
**Storage Temperature:** -40 to 75 °C  
**Ingress Protection:** IP 40  
**Operating Humidity:** 10 to 90% RH, noncondensing  
**Storage Humidity:** 5 to 95% RH, noncondensing  
**Maximum Altitude:** 2,000 m (6562 ft.)  
**Pollution Degree:** 2

### Calibration

**Calibration Interval:** 1 year; contact factory for information regarding calibration service.

**Note:** The above calibration information pertains to hardware calibration, not to be confused with "user" or "software" calibration. When performing a "user" calibration via Encore (or other software) keep in mind that sample rate affects both gain and offset of the hardware, and therefore any "user" calibration should be performed at the same sample rate that is intended for measurements.

## Ordering Information

Description	Part No.
12-channel, 24-bit ADC, Ethernet-based high-speed $\pm 10$ V isolated voltage input module, with included <i>Out-of-the-Box</i> Encore software	6230
12-channel, 24-bit ADC, Ethernet-based high-speed $\pm 60$ V isolated voltage input module, with included <i>Out-of-the-Box</i> Encore software	6231

### Accessories & Cables

Universal power supply, 24 VDC @ 0.8 A (max); requires additional cable, CA-1 (US) or CA-216 (European)	TR-60U CA-1 CA-216
Required cable for use with TR-60U; 120 V US version	CA-1
Required cable for use with TR-60U; 220 V European version	CA-216
RJ12 shielded cable, 6 conductor, SYNC, 0.3 m (1 ft.) <sup>1</sup>	CA-74-1
Ethernet crossover cables, 2.133 m (7 ft.) <sup>2,3</sup>	CA-192-7C
Ethernet patch cable, 0.457 m (1.5 ft.) <sup>2</sup>	CA-242
Ethernet patch cable, 2.133 m (7 ft.) <sup>2</sup>	CA-242-7
Stacking plate kit	190658A-01
Handle kit	HA-210-5-BK

- 1 Up to nine units can be synchronized. The total combined length of the SYNC cables is not to exceed 2.438 m (8 ft.).
- 2 Ethernet cable length must be <3 m (9.8 ft.) in order for the system to be CE Compliant.
- 3 Ethernet crossover cables should only be used for direct network connections. In particular, attempting to connect a device to a Hub using a crossover cable may prevent that network link from functioning. Some modern routers have become an exception by including logic to detect the crossover cable and allow the network link to function.



# Encore

## Out-of-the-Box Software

### Features

- Interactive measurement software for *Out-of-the-Box* setup, acquisition, display, logging, analysis, and reporting
- Included with 6000 Series Ethernet-based data acquisition modules
- Advanced feature set with no programming required
- Drag-and-drop functionality
- Easy-to-use set-up wizards
- Ability to drag data directly to Excel®
- Included data analysis tools
- Playback mode
- Sophisticated test report capability
- Incorporate multiple 6000 Series devices into one application
- Supported Windows® Operating Systems: Windows 7 (32-bit or 64-bit), Windows Vista (32-bit or 64-bit), Windows XP SP2 (32-bit), Windows 2000 SP4

### Overview

Encore is the premier *Out-of-the-Box* data acquisition software package and is included with each 6000 Series module. Encore combines ease of use with advanced functionality, including customizable data layouts, powerful analysis, and reporting capabilities. Instead of having a program to log data, another to analyze, and a third to develop report data, Encore includes the functionality of all three into one package, thus shortening the learning curve, and saving time and cost.

### Configuration

Easy-to-use set-up wizards provide rapid hardware configuration. Encore allows you to go from setup to taking measurements in minutes. Users can select one or more available devices from Encore's Hardware Configuration dialog.

Encore allows you to configure the basic acquisition or generation options, such as channel selection, acquisition rate, number of points, and input range. You can also configure start and stop triggers.

In addition, within the Channel View table, users can enable (or disable) channels, select measurement type, enable logging, perform mx+b calculation, and more. Channel View configurations can also be shared among multiple projects.

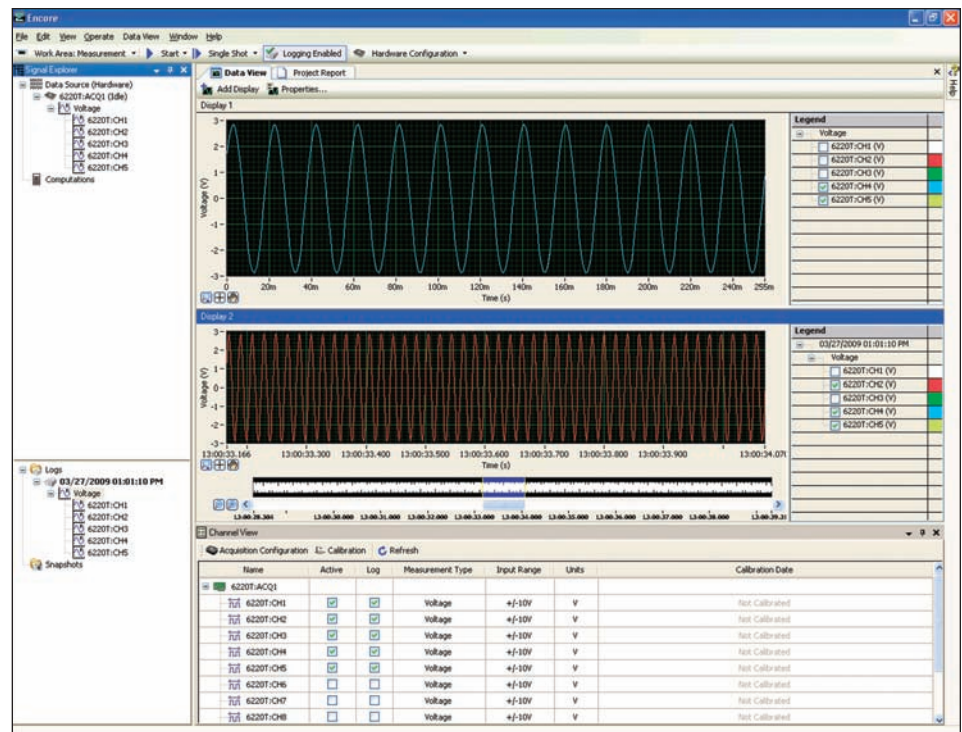

Encore offers an intuitive user interface. Data displays can be configured with multiple charts, overlapping data plots, and user selectable scales.

### Measurement

Encore allows you to develop data displays quickly with an intuitive, drag-and-drop interface. Encore also offers the ability to easily change plot colors, overlay channels (including previously recorded data), and access multiple devices. You can also display data in a variety of ways including; charts and graphs, meters, gauges, and tanks. Additionally, you can export data to other formats including Excel, ASCII and DIAdem.

### Triggering

A variety of programmable analog and digital trigger conditions are available for starting and stopping an acquisition within Encore. Analog triggers include Rising Edge, Falling Edge (with hysteresis), Above Level, Below Level, Inside Window, and Outside Window. Digital

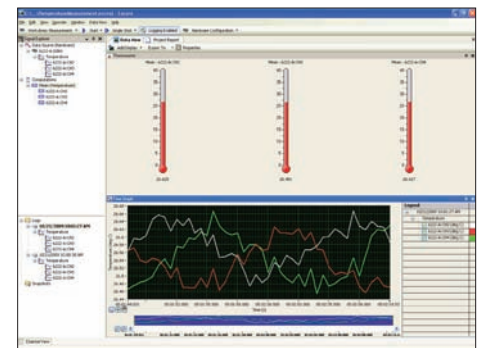

Encore can display channel data in several ways including meters, gauges, tanks and graphs

triggers include Rising Edge, Falling Edge, Level High, or Level Low. In addition, the Duration trigger may be used to stop an acquisition after a specified time.



## Analysis

Included analysis options make Encore MCC's most advanced *Out-of-the-Box* software package. Features include FFT, power spectrum, statistics, peak value, and RMS calculation. In addition, you can also create custom formulas using Encore's Create Calculated Signal function. Data can also be viewed in the playback work area. Analysis can be computed on live data as well as logged data (post processing).

Analysis options include:

- Statistics: Standard Deviation, Mean, and Variance
- Peak: +Peak, -Peak, and Peak-Peak
- RMS
- DC
- FFT
- Power Spectrum
- Minimum
- Maximum

## Export to Excel®

Signals can be exported from Encore to Microsoft Excel. When exporting signals from Encore to Microsoft Excel, the following information is exported:

- Signal name
- Export date and time
- Signal units
- Data values

## Reporting

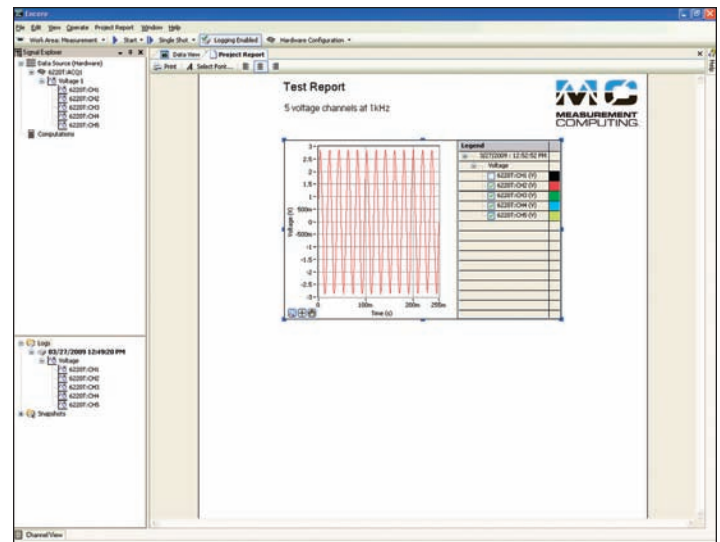

*In the Project Report tab you can drag signals from the Signal Explorer, enter text, change fonts, import images, and print or export reports to html*

Encore offers sophisticated, built-in test reporting capability which provides the ability to present data in a professional manner. With Encore's test report capability, users can easily develop in-depth test reports.

Within Encore's Project Report tab users can drag signals from the application directly into the report and then enter text, change fonts, import images and print or export reports. Once the report is complete, you even have the ability to acquire new data and easily update any previous report, without re-creating the report. The report can be edited throughout the life of the project.

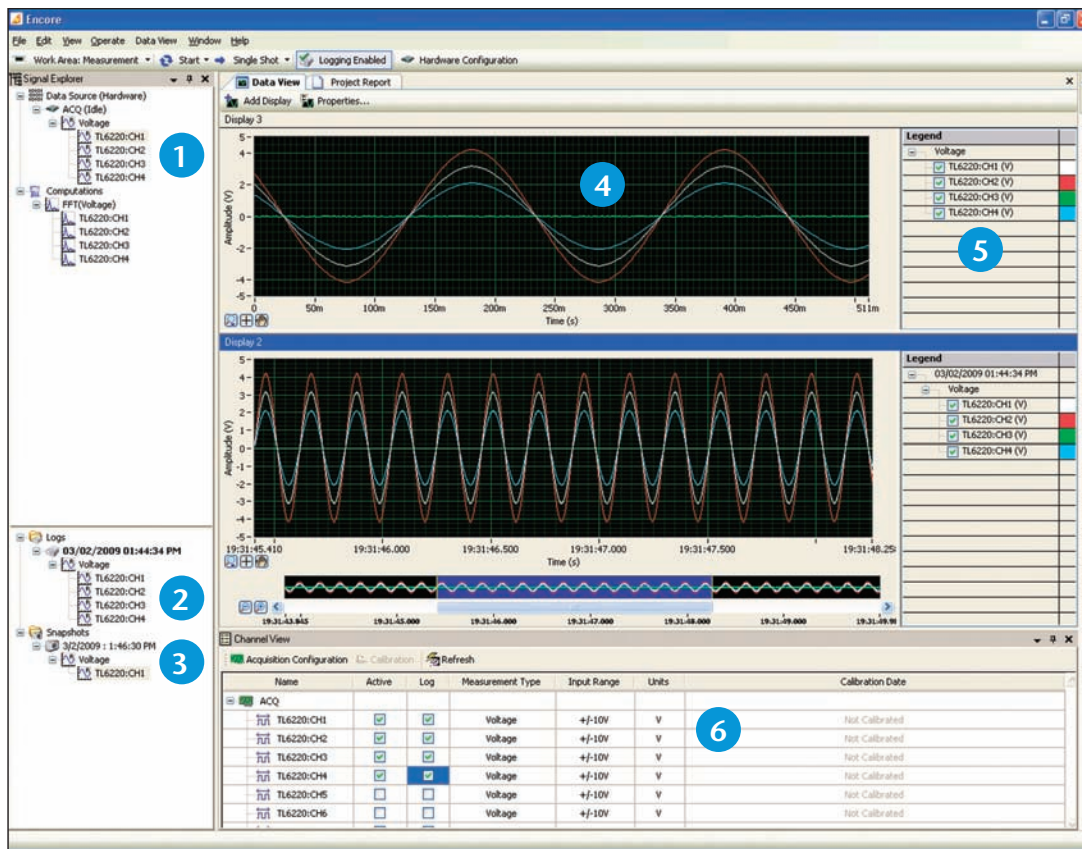

- 1 Signal Explorer** displays the data sources, computations, snapshots and logs available for your project. It also allows you to select and drag signals into the Data View. Signals can also be dragged directly Into Excel.
- 2 Log Window** displays a list of a project's logged data [including snapshots] sorted by the time at which you recorded the log or took the snapshot.
- 3 Snapshots** allow you to save a record of the current values of any signal in your project. You can use snapshots as a reference signal to compare data within the same or another project.
- 4 Data View** tab allows you to view your data by dragging signals directly from the Signal Explorer or the Log Window. The Data View tab can display signals in several formats, including graphs, charts, and various numeric representations. When you drag a signal to the Data View tab, the signal appears in a new or existing display depending on whether a display showing that type of data already exists.
- 5 Legend (Graph Legend)** lists every signal displayed in the graph and also shows its corresponding plot color.
- 6 Channel View** is a table-style section which gives you an overview of all your channels and their settings. You can enable (or disable) channels, select the measurement type, enable (or disable) logging, perform mx+b calculation, and more. You can also use the Channel View toolbar to quickly jump to Acquisition Configuration or [system] Calibration windows.