

11 Problems – 11 Solutions

Case Histories of 11 Machinery Vibration Problems – Part 2

Kevin R. Guy, Delaware Analysis Services, Inc., Francisco, Indiana

This two-part article covers a series of eleven machinery vibration problems encountered over a three year period. While each case history is not necessarily outstanding in its own right, they do show the type of equipment problems encountered in today's industrial environment. Many problems were manifested by the lack of forethought on the part of the management team and in other cases management forethought eliminated additional problems. This article will cover cases in-depth, most required rotor dynamic modeling, structural modeling or both. Each case has a lesson to be learned. Part 1 covered case histories #1-6 that were published in the March '07 issue of S&V.

Case #7 – Primary Air Fan Vibration

Problem – Thrust bearing failures were being experienced on a primary air fan. Failures occurred randomly; however, they were becoming more frequent. The fans are high pressure types and have a low flow. Both the motor and fan utilize fluid film bearings and operate at 1795 rpm.

Equipment Used for the Analysis – Iotech ZonicBook 618E with eZ-Analyst and eZ-TOMAS software, 100 mV/g accelerometers mounted with magnets, externally mounted proximity probes, calibrated 3.0 lb impact hammer, multi-channel amplifying and integrating signal conditioner, RIMAP critical speed rotor dynamic modeling software

Symptoms – Data collected, by the plant vibration monitoring contractor, indicated high 1× vibration and sidebands spaced at ± 7.98 Hz (Figures 22 and 23). Axial vibration amplitudes at times exceeded 15 mils_{pk-pk}. Axial vibration increased as the inlet damper opened. Vibration in the axial direction became high enough that it destroyed the proximity probe installed to measure the shaft thrust. An overview of the data indicated shaft vibration as much as five times higher than the seismic vibration.

Test Data and Observations – Because of the increase in vibration, in the axial direction, when the inlet damper opened it was decided to first look into the possibility of a natural frequency problem with the fan. A rotor dynamic model was developed from fan engineering drawings to look for a critical speed issue. The rotor layout is shown in Figure 24. The first mode shape is shown in Figure 25 and the critical speed map in Figure 26. The first critical speed was found to be 3222 rpm (53.7 Hz). The critical speed data indicate this fan was running well below the first critical speed.

The first impact test was to determine the disk wobble (axial) natural frequency of the fan wheel. This test indicated several natural frequencies with the lowest located at 25.93 Hz (Figure 27). The amplification of this natural frequency is around 60; which is exceptionally high. This means that any axial vibration will be amplified by 60 times. Impact tests on the shaft also indicated a natural frequency at 25.93 Hz; however, the coherence was low at 57%. This means that the natural frequency at 25.94 Hz is not on the shaft; but, rather from the axial impact. Impact tests were also performed on the outboard bearing cap in the axial and radial directions. These tests did not provide any additional information on the natural frequencies. Both the bearing cap and pedestals did indicate very stiff systems. The impact test data clearly indicate that this fan is operating near a natural frequency. The operating frequency is 29.58 Hz and the disk wobble is 25.94 Hz. The rule is one never wants to operate within $\pm 20\%$ of a natural frequency.

Next, impact tests were conducted on the shaft pedestal and foundation. These data indicated no problem frequencies.

Corrective Actions – Since both shaft data and casing data were collected during modal testing, the absolute vibration was

Based on a paper presented at the 60th Meeting of the MFPT Society, Virginia Beach, VA, April 2006.

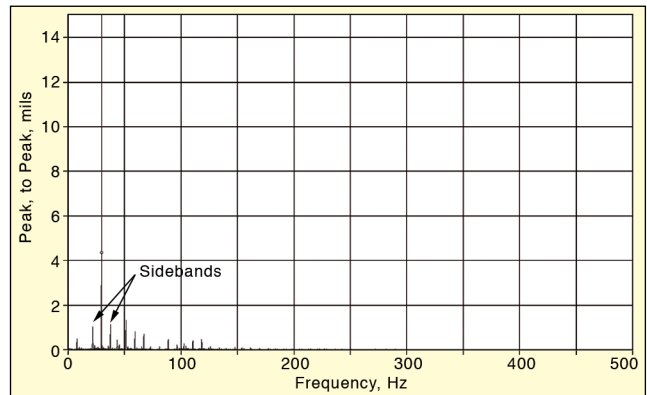

Figure 22. Inboard fan bearing cap vibration – axial.

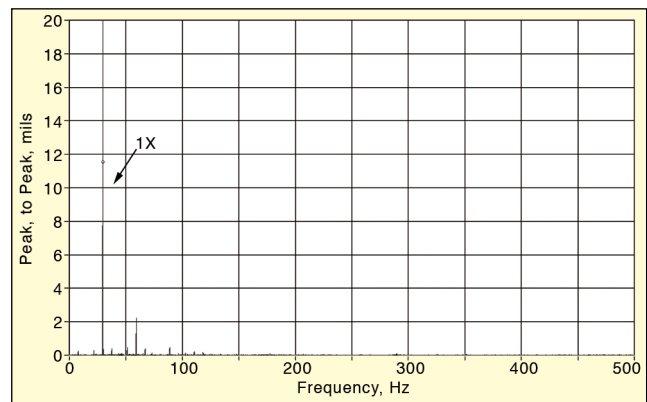

Figure 23. Inboard fan shaft vibration – horizontal.

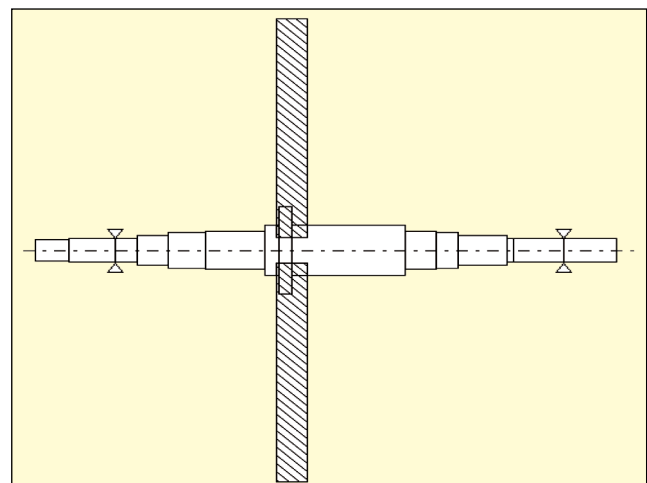

Figure 24. Rotor layout for model.

calculated. The absolute vibration is the addition of the shaft and casing vibration. This indicated a vibration of 16.0 mils_{pk-pk} at 19°. The force associated with this vibration is 1675 lb. The fan weight is stated as 2275 lb on fan engineering drawings. Normally, when balancing, a trial weight is added that would not generate a force that would be greater than 10% of the rotor weight. Since this was a very stiff system, it was decided to place a weight on the fan that would generate approximately 90% of the rotor weight. A balance weight of 10 oz was placed on the rotor. This would generate a force of 2030 lb. It was also recommended to the plant that a spider

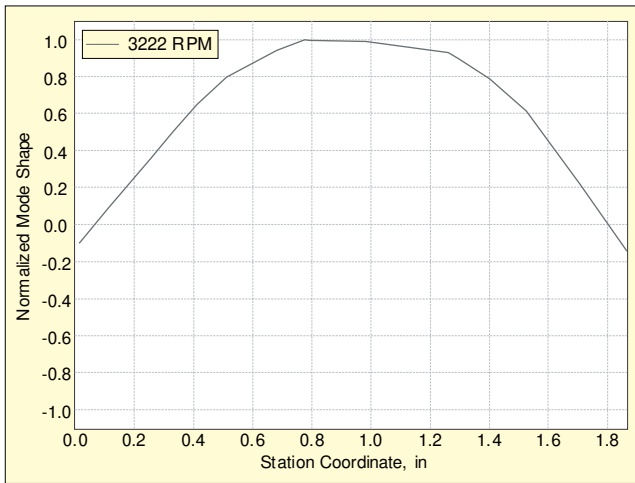

Figure 25. First critical speed.

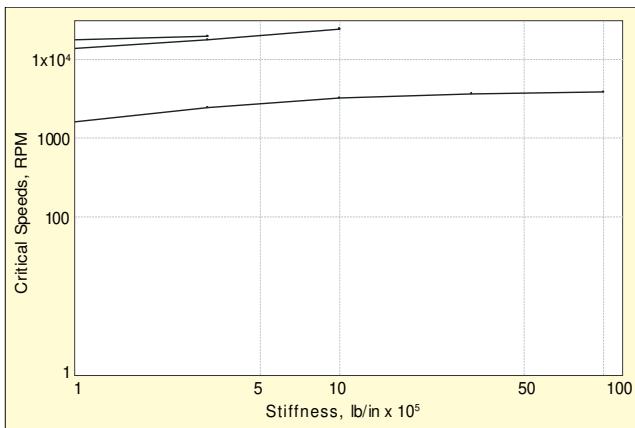

Figure 26. Critical speed map.

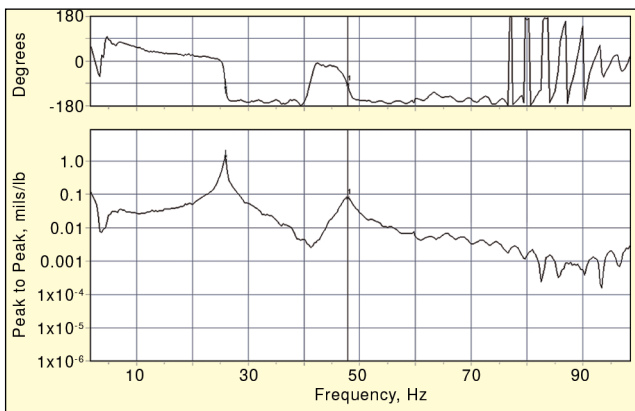

Figure 27. Disk wobble impact test.

system of six $1.5 \times 1.5 \times 0.25$ in. angle iron bracing be placed on the fan wheel to increase the disk wobble natural frequency.

Results – Balancing reduced the vibration amplitudes to below 2.0 mils_{pk-pk} on the shaft and 0.50 mils_{pk-pk} on the casing (Figure 28). Axial vibration dropped below 4.0 mils_{pk-pk}. Previously, the axial vibration was running over 22.0 mils_{pk-pk}. The plant decided not to add the bracing to the fan wheel because of cost.

Discussions with the fan manufacturer after the completion of this project were very interesting. The manufacturer revealed that they did indeed have a disk wobble natural frequency as discovered in this project. In fact, their fix was to install stiffeners of the same size that was recommended during the analysis of the project. The plant was involved in these discussions.

Even with the plant involved in the discussions and knowing how to fix the problems, they still decided not to add the stiffeners. Their reasoning was the cost of lost power generation. There are six primary air fans on this unit and they felt that the cost

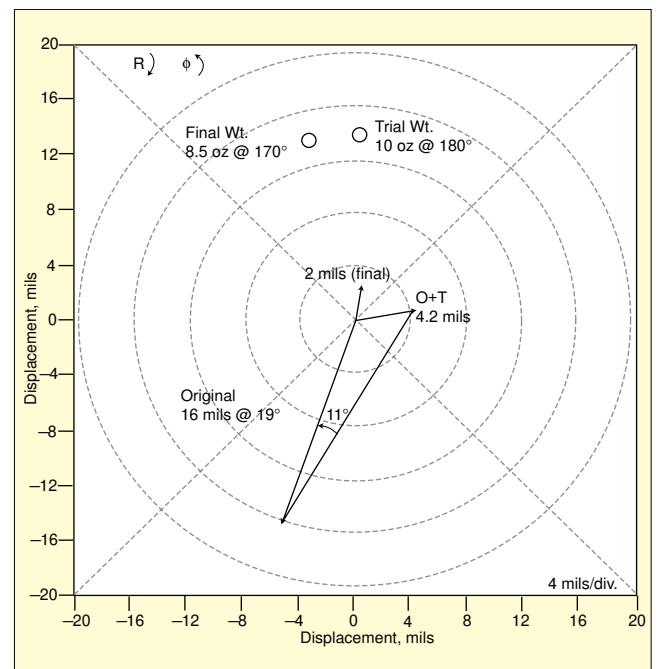

Figure 28. Final balance results.

would be too high. During the time this analysis took place, this fan was lost to power generation for almost 20 days during the winter heating time.

Conclusions – This fan operates within 13% of the axial natural frequency. Any time a piece of equipment operates with in $\pm 20\%$ of a natural frequency, the natural frequency will be excited. Unbalance problems on this fan and any sister fan should be kept below 1.0 mils_{pk-pk} on the casing and 2.0 mils_{pk-pk} on the shaft.

Case #8 – Primary Air Fan Axial Vibration

Problem – This is a follow up problem to Case #7. This is a sister fan on the same power generation unit. This fan had been operating without a problem when it suffered a failure of the fan thrust bearing. The fan was completely rebuilt by a maintenance contractor. Upon return to operation, the fan had high casing vibration in the horizontal and axial directions. Because of the results of the previous case, the plant decided the fan needed to be balanced. The plant directed the vibration monitoring contractor to balance the fan, but it could not be completed. The vibration was all at 1x and the phase angles were stable.

Equipment Used for the Analysis – IOtech ZonicBook 618E with eZ-TOMAS and eZ-Balance software, 100 mV/g accelerometers mounted with magnets, externally mounted proximity probes, multi-channel amplifying and integrating signal conditioner, TEAC 16 channel digital recorder

Symptoms – The fan would run with high vibration amplitudes; however, the data appear to be stable in amplitude and phase (Figure 29). The vibration data, while appearing stable, changed over time. It took more than twenty minutes of operation to show a change.

Test Data and Observations – Initial vibration data, while appearing stable, was not. The data, trended over time, showed the vibration amplitude increase with time (Figures 29-31). Figure 33 shows a coast down. The coast down and vibration trend are classic indications of a rub condition.

Corrective Actions – It was recommended the fan be shutdown and inspected for a rub. Since this fan was just overhauled, the rub was most likely caused by a shaft seal. Additionally, it was recommended that the alignment be checked to find out if the vertical alignment was off and possibly causing the rub.

Results – The plant had the company who overhauled the fan come in to inspect the fan for a rub. This contractor said, after their inspection, that only a very slight rub was found and it could not have caused the vibration issues. The contractor stated that the fan only needed balancing.

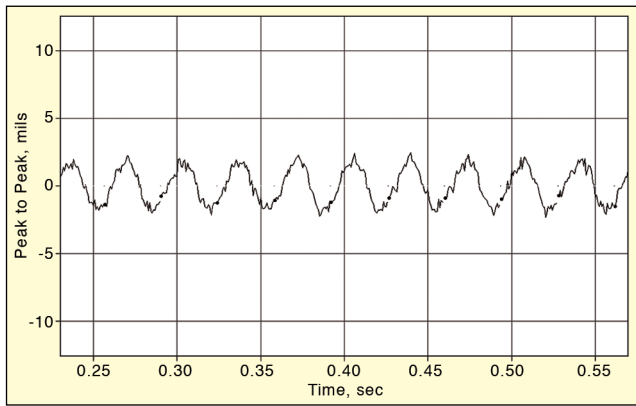

Figure 29. Inboard bearing proximity probe.

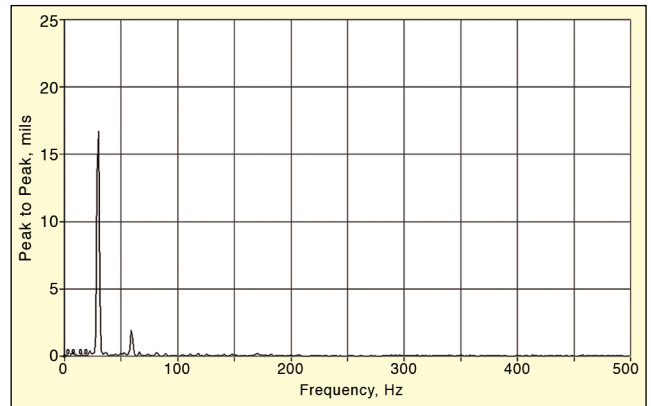

Figure 32. Inboard fan bearing proximity probe – high amplitude.

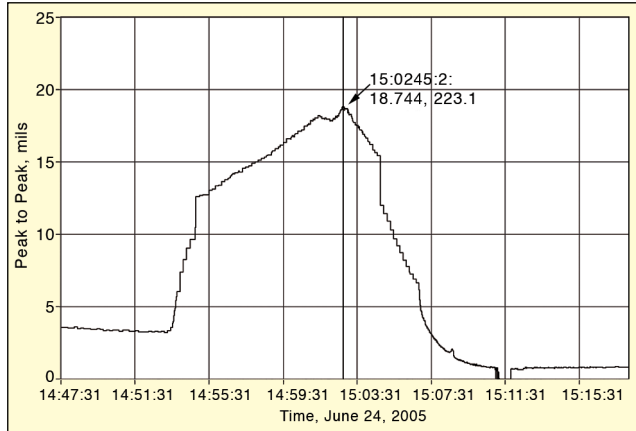

Figure 30. Inboard fan proximity probe - 1x vibration trend.

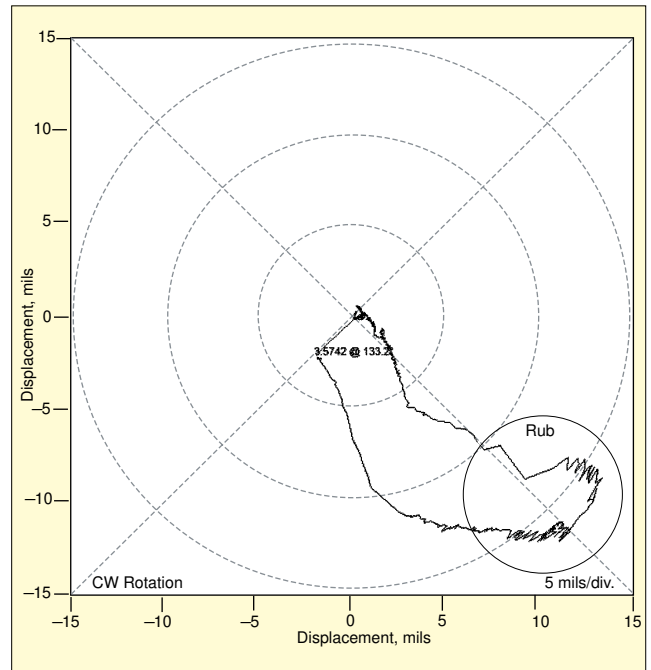

Figure 33. Inboard fan bearing proximity probe – coast down.

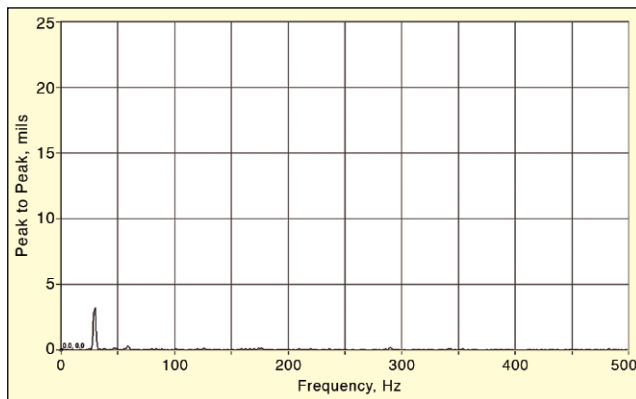

Figure 31. Inboard fan bearing proximity probe – low amplitude.

The fan still had a significant vibration after this inspection. In fact it was impossible to tell the difference between the data from before and after the inspection.

The shaft seals eventually were removed and ground down to eliminate the rub. While inspecting the seals, it was fairly obvious that they suffered a hard rub. The seals had to be ground down 0.05 in. to remove the rub defect. Even with this grinding, a slight rub was still present. This showed on the trend plot when the fan was put back in service (Figure 34).

Conclusions – This vibration problem was caused by a maintenance contractor who had very little experience repairing fans. This lack of experience caused the rub condition when they could not get the correct clearance setting for the shaft seals.

The excessive vibration amplitudes were the result of the rub and the axial natural frequency close to running speed (see Case #7). The rub excited the natural frequency causing the vibration of the rub to be amplified. If the plant had taken earlier recommendations to add supports to the fan wheel to help control the natural frequency, this problem would not have been as severe. Without the added stiffeners, the vibration amplification ("Q" factor) was

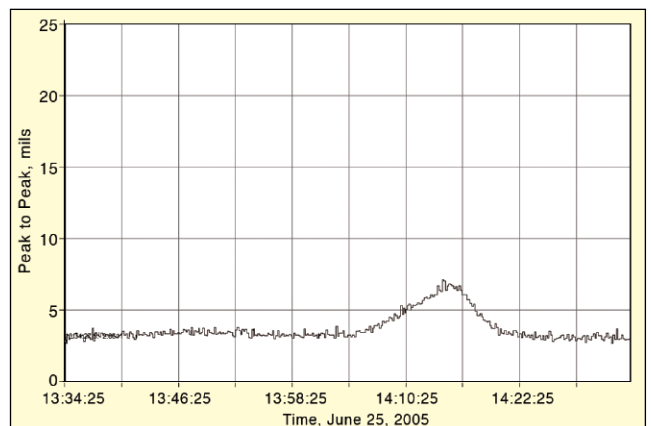

Figure 34. Inboard fan bearing proximity probe – trend plot.

over 20. The vibration contractor, under pressure from the plant to balance the fan, did not allow it to run long enough to see the rub. The fan needed to run almost 30 minutes before the effect of the rub could be seen.

Case #9 – Induced Fan Replacement With Analysis

Problem – Two large induced draft fans were scheduled for replacement and the plant had concerns pertaining to their ability to operate without vibration issues. The fans were to be replaced with larger fans. This was due to EPA air quality issues in the

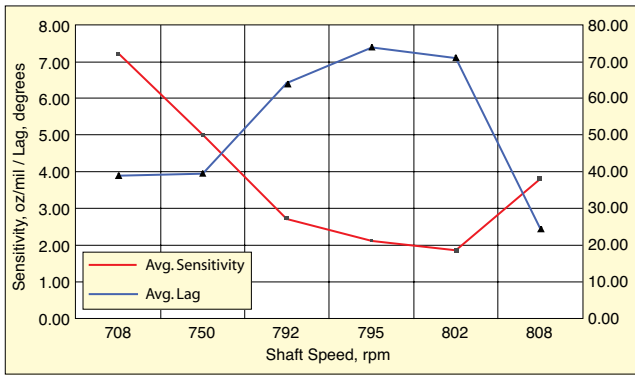

Figure 35. Lag angle and sensitivity versus shaft speed.

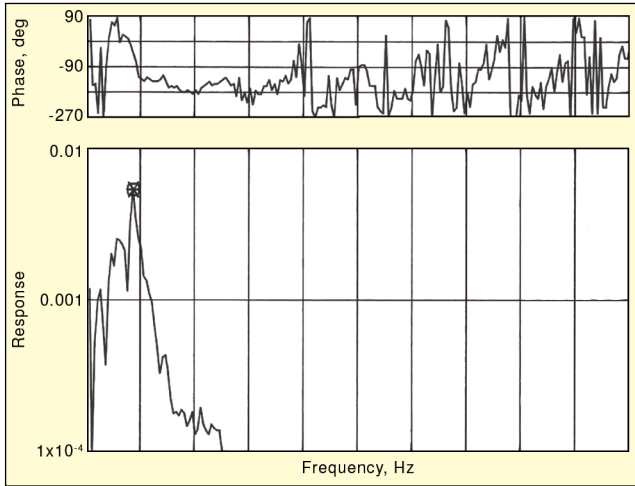

Figure 36. Shaft impact test.

power industry. These two new fans were to be installed on the present fan foundations. The present fans were variable speed and were driven with a single speed motor that utilized a fluid drive to vary the fan speed. The outboard fan bearing sits on a free standing foundation while the inboard fan bearing shares the foundation for the fluid drive. The plant was concerned if there were any natural frequencies or critical speeds present on the installed fan or with the new fan that will be installed.

Installation files indicated the presently installed fan rotor weights to be around 43,323 lbs. The estimated first natural frequency was to be 115% (15.39 Hz, 923 cpm) of running speed and the first critical to be 125% (16.75 Hz, 1005 cpm). The fan normal operating speed is around 800 rpm (13.33 Hz). Therefore; any natural frequency or critical speed within $\pm 20\%$ of the operating speed will be excited:

$$f_n = \sqrt{\frac{k}{m}} \quad (2)$$

where

K = stiffness (lb/in)

M = mass (lb-sec²/in)

Using the weight of the rotor and a general overall stiffness of 1,000,000 lb/in. along with the above formula, the natural frequency of this system should be 901 rpm. This is just 4% above running speed of the fan.

Equipment Used for the Analysis – IOtech ZonicBook 618E with eZ-TOMAS, eZ-Analyst and eZ-Balance software, Spectral Dynamics SD385 FFT analyzer, 100 mV/g accelerometers mounted with magnets, 3.0 lb instrumented impact hammer, permanently mounted proximity probes, multi-channel amplifying and integrating signal conditioner, TEAC 16 channel digital recorder, Crit Speed critical speed modeling program, RIMAP[®] critical speed rotor dynamic modeling software.

Symptoms – There was a history of balance sensitivity issues around 800 rpm on both of the current fans. The sensitivity for balance weights drops from 7 oz/mil at 700 rpm to 2.0 oz/mil at

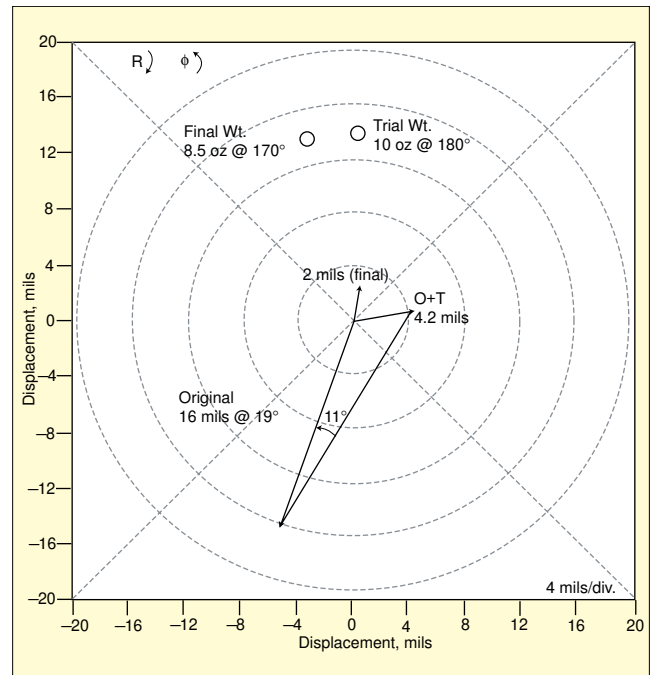

Figure 37. Outboard fan bearing – vertical proximity probe vibration change due to applied weight.

800 rpm. Additionally; the lag angle increases from 30° at 700 rpm, to 90° at 800 rpm. These data indicate the possibility of a natural frequency close to operating speed. Anytime sensitivity drops as speed increases, it indicates that the equipment is approaching a natural frequency (Figure 35).

Test Data and Observations – Impact tests were run on the shaft in the horizontal and vertical axes (Figure 36). One concern with the shaft impact data is the response at the natural frequency. The natural frequency identified by impact tests on a nonrotating shaft is the natural frequency of the shaft at rest. A summary of all impact tests can be found in Table 2. The horizontal and vertical natural frequencies at 17 Hz (1020 cpm) and 23.0 Hz (1380 cpm) are a problem since they are so close to the operating speed of the shaft.

Stiffness testing was performed next. The most effective way to determine stiffness dynamically is to apply weights and measure the response. A polar plot of the response from the outboard fan bearing vertical proximity probe is shown in Figure 37.

By placing a known weight on the rotating element you can calculate the force of this weight by the formula:

$$F = me\omega \quad (3)$$

where:

F = force (lbs)

m = mass (weight/386 in./sec²)

Table 2. Summary of impact test data (RD = Ring Down).

Location	Direction	Natural Frequency f_n (Hz)	Amplification Factor Q	Critical Damping C/C _c	Stiffness lb/in. K
Shaft	Horiz.	17.0	4.9	0.101	No RD
Shaft	Vert.	23.0	10.0	0.050	6.48×10^6
Wheel	Axial	30.0	17.5	0.029	–
Plate		95.5	104	0.005	136,000
		162.5	–	–	–
Blade	–	301.3	No RD	No RD	No RD
Bearing Cap	Horiz.	50.0	1.9	0.261	4.37×10^6
Inboard		63.0	2.4	0.207	–
Bearing Cap	Horiz.	50.0	4.9	0.102	3.36×10^6
Outboard		63.0	4.0	0.124	–
Inboard	Horiz.	50.0	No RD	No RD	7.64×10^6
Steel Pedestal		63.0	–	–	–
Outboard	Horiz.	50.0	No RD	No RD	7.16×10^6
Steel Pedestal		63.0	–	–	–

e = eccentricity of weight (in.)

ω = angular velocity = (rpm) $(2\pi \text{ radians})/60 \text{ sec}$

The calculated force is then divided by the change in vibration measured in mils_{pk} . The result of the calculation is the stiffness in pounds/in.

There is a distinct difference in the data depending on whether the weights were installed on the heavy spot (9.31 oz @ 230°) or light spot (29.98 oz @ 50°). These data are affected by the eccentricity of the bearing. The data collected with the 9.31 oz installed at 230° is realistic. The stiffness determined from the test is in line with the stiffness data collected when testing similar equipment. Table 3 and Table 4 contain the data for the horizontal and vertical axes.

The only data that appears to be questionable, from the weight addition, is shaft stiffness. Calculations put this stiffness at around $3.56 \times 10^6 \text{ lb/in}$. This is based on the stiffness of the largest diameter of the shaft which is the controlling stiffness. This stiffness could be around $2.13 \times 10^6 \text{ lb/in}$. based on information calculated in a forced response modeling program. However, either number does not change the effective stiffness of the system appreciably.

One further piece of data was the coast down (Figure 38). This shows a rapid drop in vibration as the shaft coasts down from operating speed. When the operating speed is cut in half, the vibration should drop by a factor of four. In this case the vibration dropped by 60% with a decrease in speed of only 100 rpm.

A rotor dynamic model was developed from the generated data (Figure 39). This model calculated a shaft critical speed of 836 rpm (Figure 40) which correlates with the balance sensitivities and lag angle changes seen in Figure 35. These data were provided to the fan manufacturer to utilize when designing a new fan. It was also requested to balance the fan to the API balancing specification of $2W/n$. Additionally, the plant requested that the new fans be supplied with dual proximity probes on each bearing. A keyphaser was also required.

Corrective Actions – The fan manufacturer was cautioned about the current critical and natural frequency problems. The plant requested that no natural frequencies be located within $\pm 20\%$ of operating speed. The design operating speed is 860 rpm (28.66 Hz).

Results – The new fan was designed and the specifications given to the plant for review. This information along with the data from the installed fan were reviewed. A rotor dynamic model was developed with the new fan dimensions and new bearing data. The model showed that the new fan would have an installed critical speed of 1149 rpm, 24% above the maximum running speed (Figures 40-42).

Conclusions – This fan when installed ran without any vibration problems. The critical speed is far enough above the maximum running speed that there is no excitation. The fan operated correctly the first time, because this utility did it right. They spent the time to investigate the in-service fans and then looked into the design of new fans. These fans have operated for three years without a single balance or vibration issue.

Case #10 Turbine Generator Shaft Alignment

Problem – Operations personnel found babbit material in the oil drain of bearing #2 following a unit trip caused by boiler problems. This is a D8 General Electric turbine generator rated at 300 megawatts. It has been in service for 30 years and was last overhauled in May 2002. The unit has dual proximity probes installed on each bearing; however, the utility relies on the old shaft rider system for vibration monitoring.

Table 3. Horizontal stiffness from installed weights.

Position	K (lb/in.) on 9.31 oz	K (lb/in.) on 29.98 oz
Inboard Fan Shaft	11.0×10^5	6.50×10^5
Inboard Fan Bearing	14.1×10^5	4.87×10^5
Inboard Bearing Pedestal.....	12.9×10^5	6.10×10^5
Inboard Foundation.....	19.3×10^5	9.94×10^5
Outboard Fan Bearing.....	7.03×10^5	4.60×10^5
Outboard Bearing Pedestal.....	11.9×10^5	6.54×10^5
Outboard Foundation.....	12.9×10^5	9.03×10^5

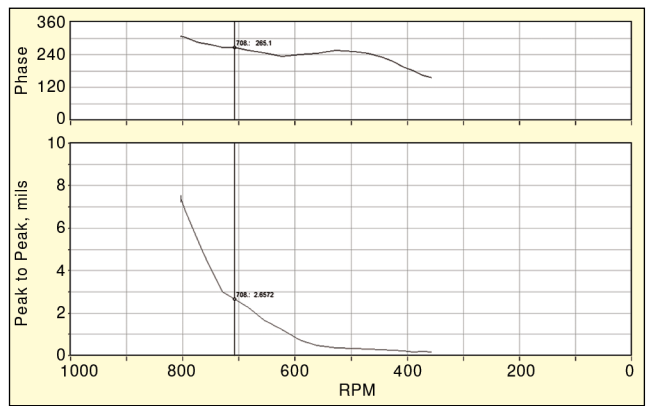

Figure 38. Outboard fan bearing – vertical proximity probe – coast down.

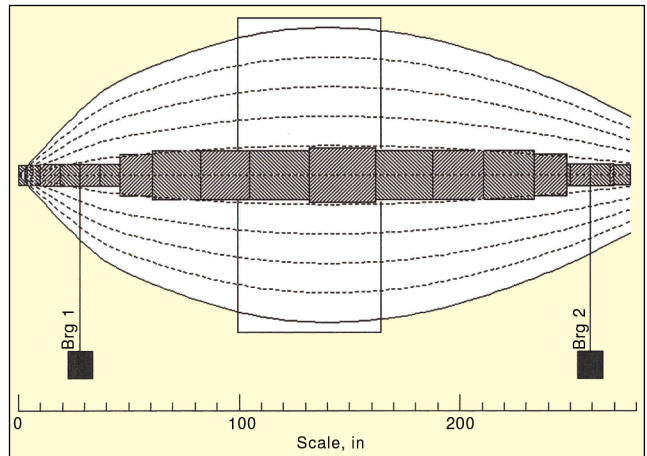

Figure 39. Rotor dynamic model installed fan.

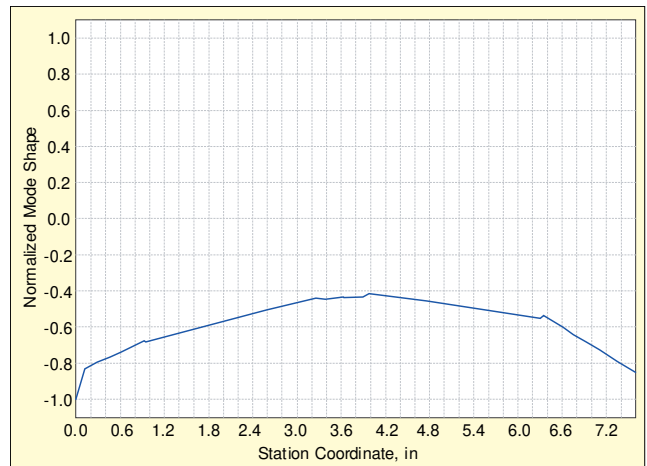

Figure 40. Shaft mode – first critical – 1149 rpm.

Equipment Used for the Analysis – IOtech ZonicBook 618E with eZ-TOMAS, eZ-Analyst and eZ-Balance software, dual proximity probes and TEAC 16 channel digital recorder.

Symptoms – During the coast down, operations personnel witnessed vibration amplitudes on bearing #2 over 8.0 mils_{pk-pk} (Figure 43). Additionally, the operating temperature of bearing #2 was over 210° F (Figure 44). The normal operating temperature of this bearing would be approximately 180-185° F. Drain oil temperatures were almost 50° F above the inlet temperatures. Inlet oil

Table 4. vertical stiffness from installed weights.

Position	K (lb/in.) on 9.31 oz	K (lb/in.) on 29.98 oz
Inboard Fan Bearing	30.9×10^5	21.6×10^5
Inboard Sole Plate.....	51.3×10^5	24.8×10^5
Outboard Fan Bearing.....	14.7×10^5	14.7×10^5
Outboard Sole Plate.....	9.97×10^5	39.7×10^5

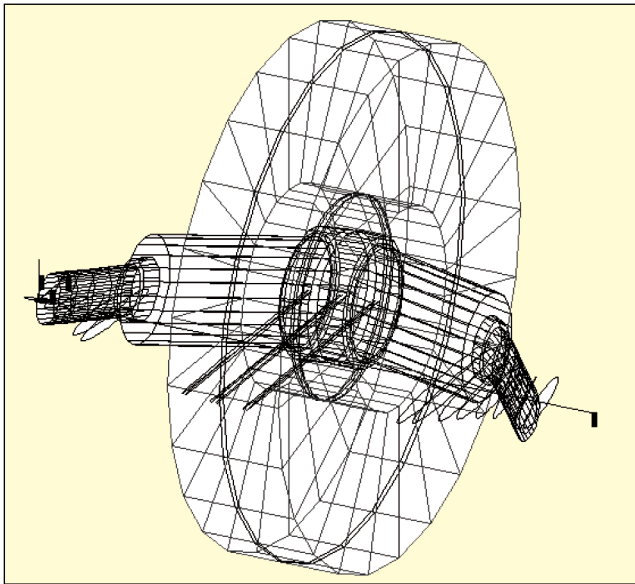

Figure 41. Shaft mode - first critical - 1149 rpm.

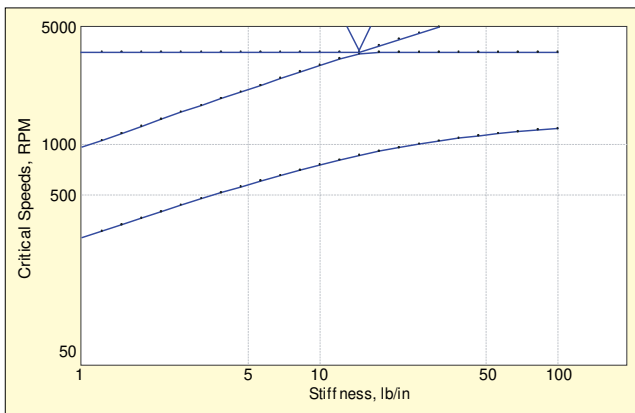

Figure 42. Critical speed map.

temperatures run about 115° F. The recommended minimum inlet temperature is recommended to be 120° F. The metal temperatures of bearings #1 and #3 respectively were 193° F and 164° F.

The bearing #2 temperature being almost 50° above the bearing #3 metal temperature is not normal. These data indicate that bearing #2 is heavily loaded and bearing #3 lightly loaded. The normal setting for bearing #3 to have a fairly heavy load. This is because bearing #3 is susceptible to oil whirl or whip problems if the loading is light.

Review of past operating vibration data trends do not show vibration amplitudes that would be of concern. In fact all vibration amplitudes were below 3.0 mils_{pk-pk}. One major concern with the coast down data is the location of the critical speed on bearing #2. The critical speed of 1957 rpm is the first critical speed of the low pressure turbine. Bearing #2 is on the HP/IP turbine rotor.

Test Data and Observations – Since the unit was offline due to the boiler trip, it was decided to collect data during the start up and see if the vibration amplitudes were of a magnitude equal to the coast down amplitudes. Vibration data would be collected from the installed proximity probes on bearing #1 thru bearing #3. Gap voltage measurements of the proximity probes would also be collected. This would show how much the shaft has moved since the probes were installed during the Spring 2002 outage. The original gap voltages in V dc were as follows:

Bearing 1 – x = -9.99, y = -10.00

Bearing 2 – x = -10.01, y = -10.00

Bearing 3 – x = -10.00, y = -10.01

The gap voltages in V dc measured on the turning gear before start up were as follows:

Bearing 1 – x = -10.74 (shaft lowered 3.75 mils), y = -10.65 (shaft lowered 3.25 mils)

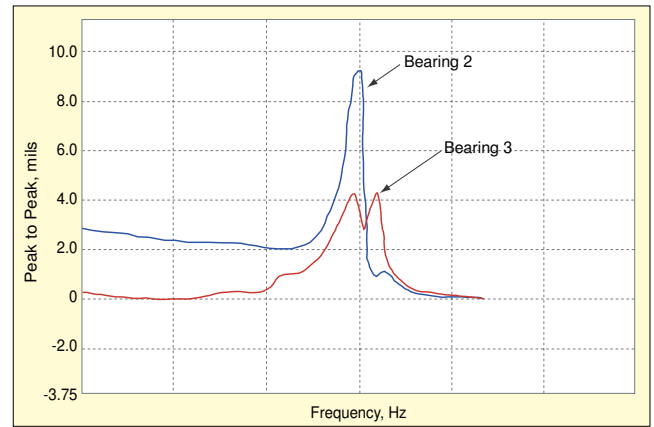

Figure 43. Bearing #2 coast down - shaft rider data.

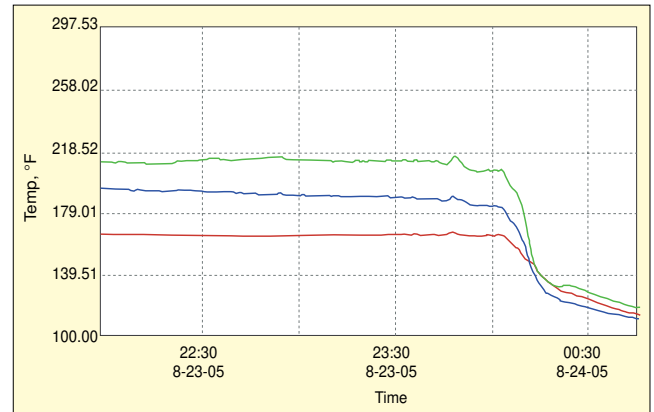

Figure 44. Bearing metal temperature trend data - pre-shutdown.

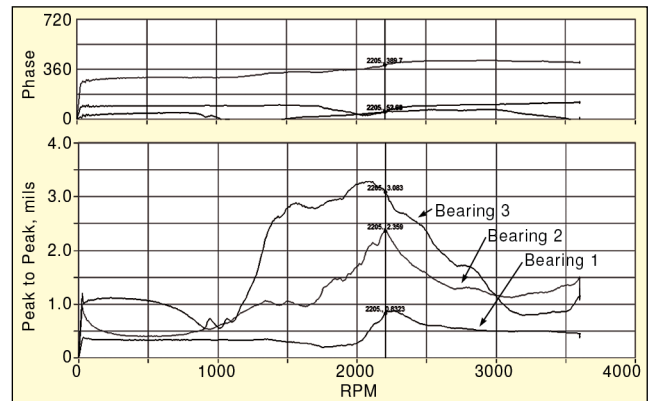

Figure 45. Bode plots - bearing #2 - bearing #4.

Bearing 2 – x = -10.96 (shaft lowered 4.75 mils), y = -10.77 (shaft lowered 3.85 mils)

Bearing 3 – x = -9.72 (shaft rose 1.4 mils), y = -8.75 (shaft rose 6.3 mils)

The gap voltages in V dc measured when the unit was generating 50 MW were as follows:

Bearing 1 – x = -9.32 (7.1 mils shaft rise from turning gear, 3.35 mils shaft rise from Spring 2002), y = -9.41 (6.2 mils shaft rise from turning gear, 2.95 mils shaft rise from Spring 2002)

Bearing 2 – x = -9.80 (5.8 mils shaft rise from turning gear, 1.05 mils shaft rise from Spring 2002), y = -9.96 (4.05 mils shaft rise from turning gear, 0.2 mils shaft rise from Spring 2002)

Bearing 3 – x = -7.83 (9.45 mils shaft rise from turning gear, 10.85 mils shaft rise from Spring 2002), y = -8.08 (3.35 mils shaft rise from turning gear, 9.65 mils shaft rise from Spring 2002)

Bode plots from bearing #1 thru bearing #3 indicate the same first critical speed at 2205 rpm (Figure 45). The plot for bearing #3 is very broad and has the highest amplitude of 3.2 mils_{pk-pk}. Bearing #2 has a distinct peak at the critical speed. However, bearing #2 is on the HP/IP rotor and the critical speed should be

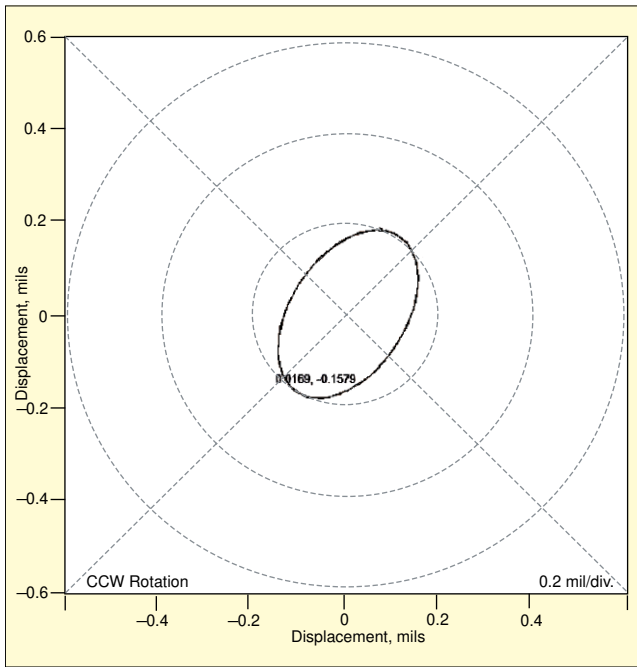

Figure 46. Bearing #1 orbit.

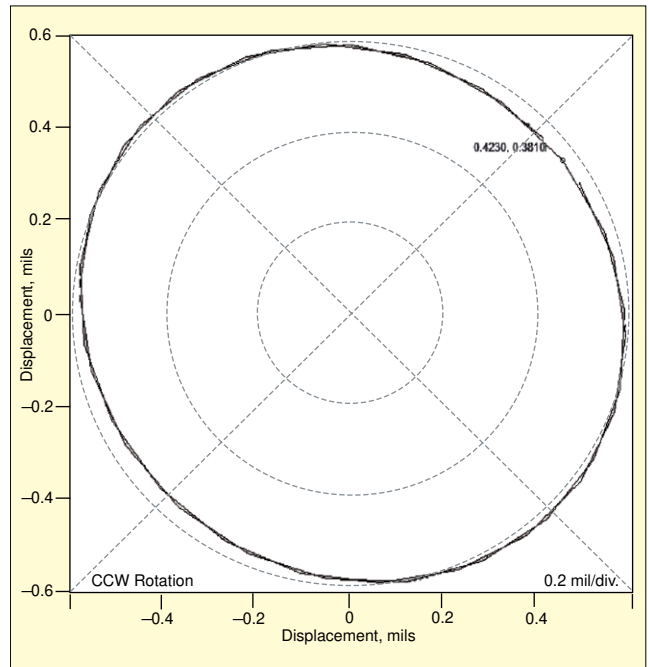

Figure 48. Bearing #3 orbit.

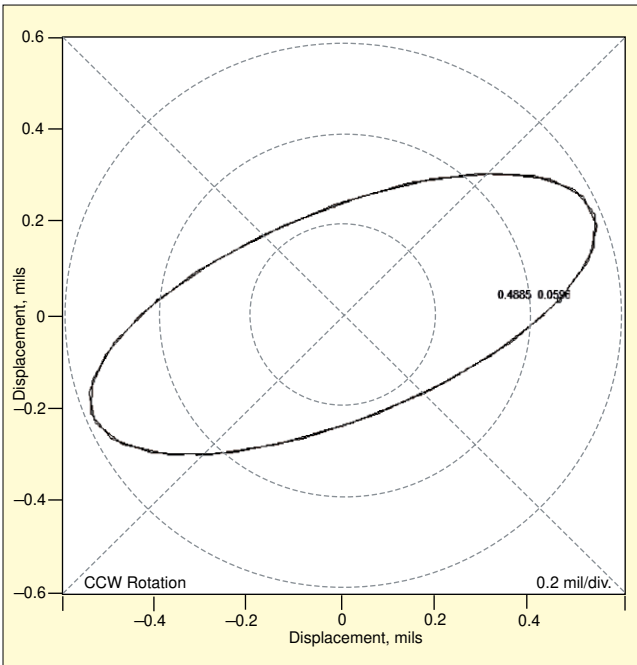

Figure 47. Bearing #2 orbit.

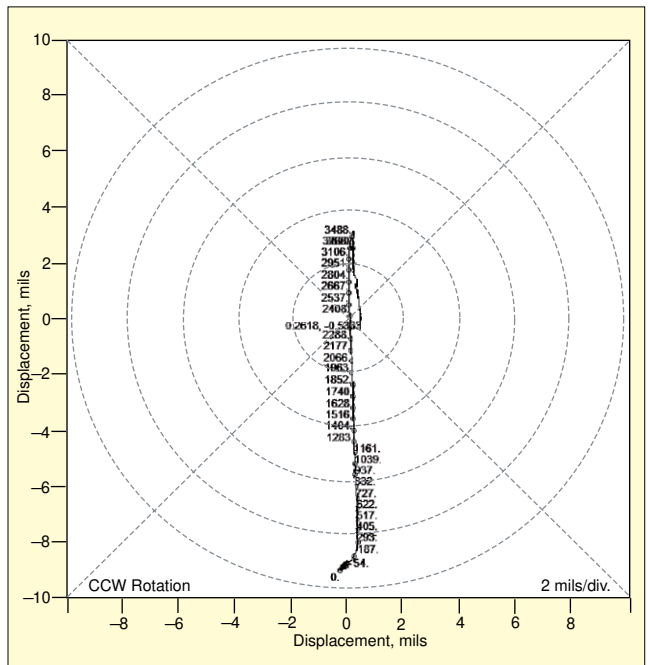

Figure 49. Bearing #1 centerline plot.

around 1600 rpm. This appears to be the critical speed for the low pressure turbine.

Shaft orbits for the three bearings (Figures 46-48) have different pattern orientations. Bearing #1 and bearing #2 orbits are elliptical; however, their orientation is not the same. They should basically have the same orientation. The bearing #1 orbit orientation is what one should expect for bearing #2. Bearing #2 is more flat and laying to the right. Bearing #3 is round which is not normal. This indicates the bearing is completely unloaded.

The two most likely causes of this unloading are a wiped bearing or misalignment. Centerline plots show where the centerline of the shaft is sitting in relation to the bearing centerline. These plots indicate the presence of alignment issues. Centerline plots take data from the x and y proximity probes on each bearing and plot them against each other versus the gap voltage when the proximity probes were installed.

Bearing #1 starts at the bottom of the bearing, goes above the bearing centerline and then settles below the centerline as the unit

reaches operating speed. This is normal (Figure 49). Bearing #2 starts very low and then rises as the bearing is loaded (Figure 50). This heavy load causes the bearing temperature to run above 210° F. Bearing #3 starts above the centerline and operates above the centerline in the unloaded condition (Figure 51).

Time and spectrum plots do not indicate anything out of the ordinary that would cause concern for operations. All vibration was at running speed and below 3.0 mils_{pk-pk}.

One note is that during the start up, after the outage in the Spring of 2002, this turbine suffered several severe rubs in the LP hood. The vibration excursions due to the rubs caused a trip on high vibration amplitudes for bearing #3.

Corrective Actions – It was recommended to operate the unit normally. However, during coast downs, the bearing metal temperatures and vibration amplitudes should be monitored closely. Any excursion of bearing metal temperatures on coast down should be investigated.

It would be advisable to get coast down data and calculate the

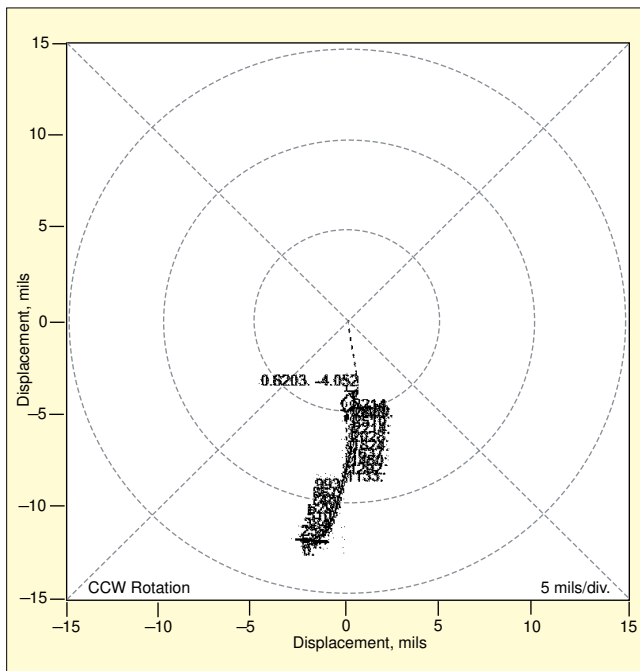

Figure 50. Bearing #2 centerline plot.

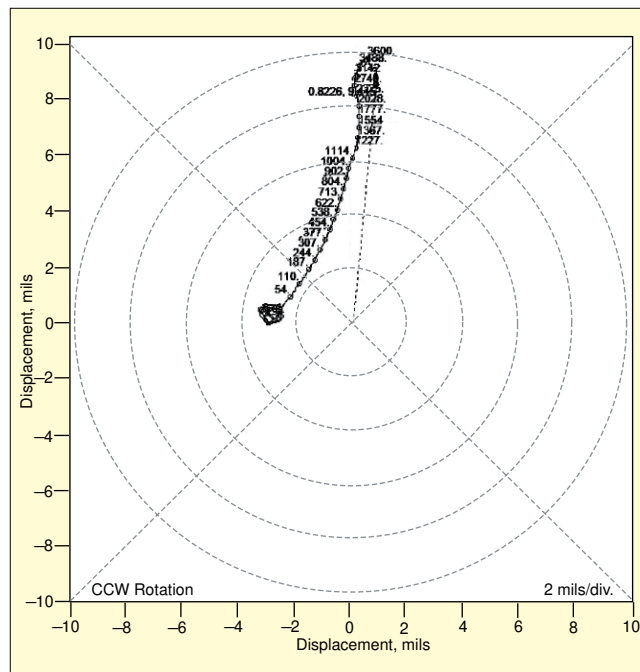

Figure 51. Bearing #3 centerline plot.

amplification factor. The amplification factor indicates how much the vibration increases when the shaft passes thru a critical speed. Acceptable criteria is that amplification factors ('Q' factor) should be less than 6. The Q factor for the coast down in Figure 44 is 11.3, which is too high. The damping is 0.044 of critical; very light for a sleeve bearing. This is a very narrowly damped critical speed. This means that the shaft goes thru the critical speed very quickly; not what one wants. The best situation is for a critical speed to be spread over a large range with low amplification.

Results – This unit is running reliably with the bearing metal temperatures still high; however, they remain stable.

Conclusions – This unit has alignment problems. Post start up reports after Spring 2002 raised questions about the alignment. The unit has run for 27 months in this condition. Recently, babbitt particles have shown up in the bearing #2 oil drain, but this unit has been very reliable. The only concern is the elevated temperatures of bearing #2. Operating over 210° F for a unit of this size is a concern and can lead to babbitt fatigue and possible wiping

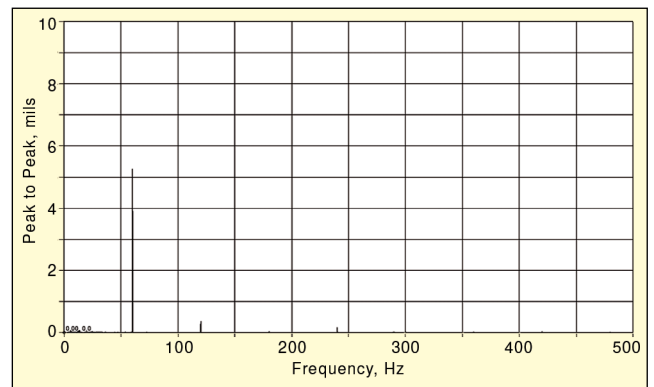

Figure 52. Bearing #9 – proximity probe "X".

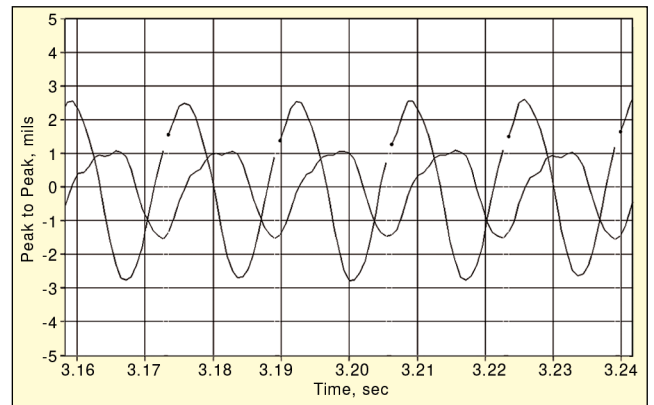

Figure 53. Bearing #9 proximity probes.

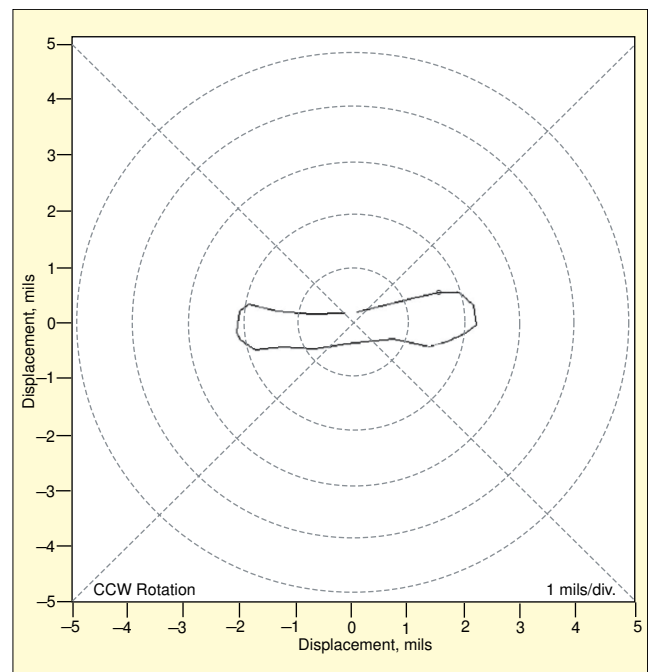

Figure 54. Bearing #1 orbit.

of the bearing.

Case #11 Turbine Generator Alignment and Rub

Problem – The unit has exhibited vibration problems on several bearings since a Spring 2005 turbine overhaul. Bearing #9, the first generator bearing, has been operating with vibration amplitudes around 6.0 mils_{pk-pk}. The phase angles have been fairly consistent; however, recently there was a sudden shift of about 100°.

Balance shots have been placed in the 'D' coupling to try to lower the vibration on bearing #9. This had little effect on the generator (bearing #9) vibration. The vibration on bearing #9 does have random excursions; however, the plant has not been able to correlate

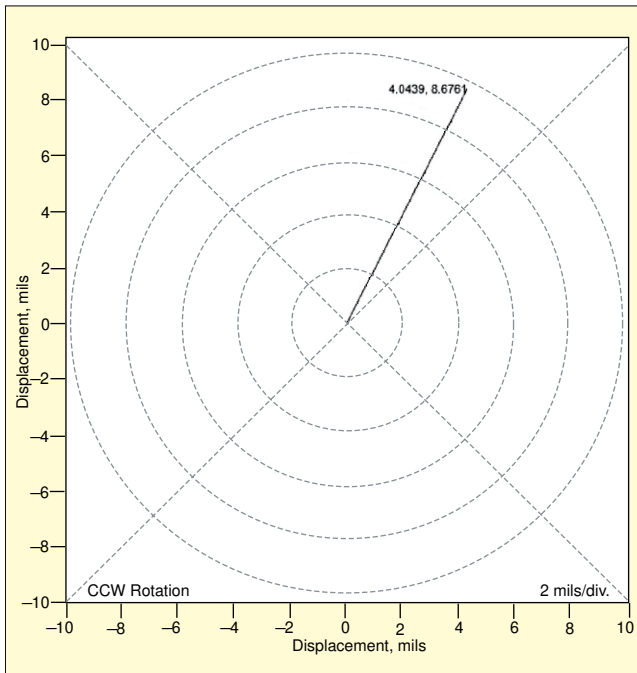

Figure 55. Bearing #1 centerline plot.

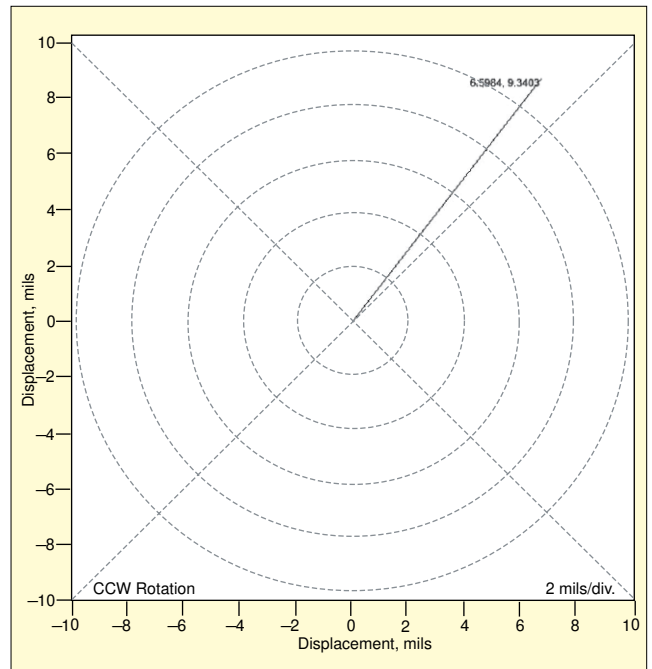

Figure 57. Bearing #9 shaft centerline.

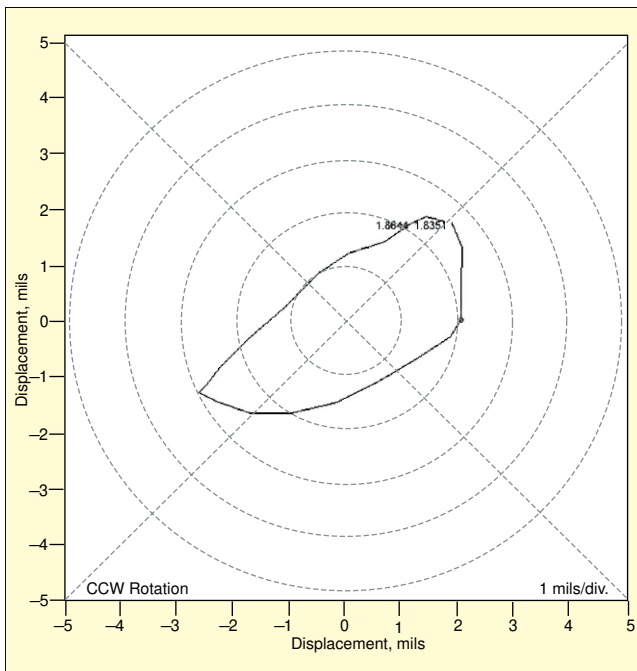

Figure 56. Bearing #9 orbit.

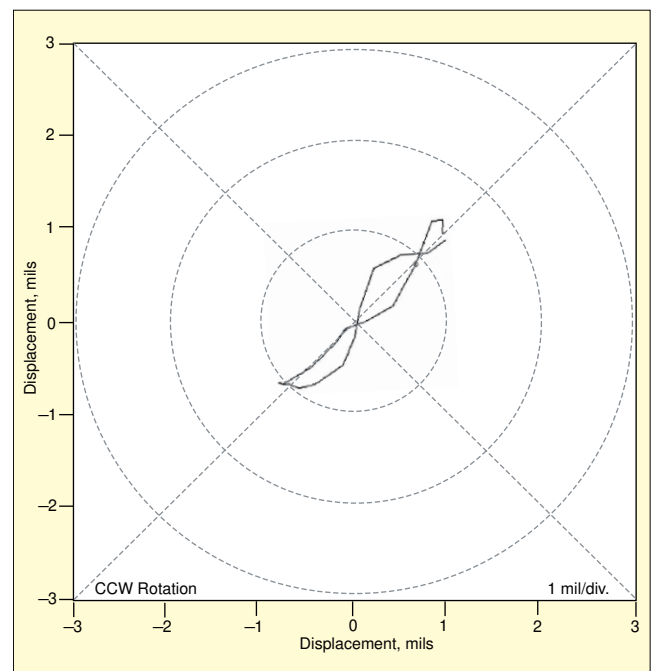

Figure 58. Bearing #10 orbit.

it to any load changes or specific operational parameters.

This is a G-3 General Electric turbine generator. The turbine has separate high pressure and intermediate pressure (HP/IP) turbines. There are two low pressure turbine rotors. The generator bearings are #9 and #10. Bearing #11 is the exciter steady rest bearing.

Equipment Used for the Analysis – IOtech ZonicBook 618E with eZ-TOMAS, eZ-Analyst and eZ-Balance software, internally mounted dual proximity probes, Bently Nevada System One software.

Symptoms – Bearing #9 vibration was erratic and unsteady. Vibration amplitudes did not correlate to any generator load settings. Bearing #9 vibration amplitudes vary from 4.0 mils_{pk-pk} to over 7.0 mils_{pk-pk}. All vibration is at running speed (Figure 52). The time history plot from the bearing #9 proximity probes indicates clipping (Figure 53).

Test Data and Observations – The data were collected with 3200 lines of resolution with an F_{max} of 500 Hz. Time and spectrum data were collected from each proximity probe. Additionally, phase and

amplitude data along with shaft orbits and centerline plots were also collected. Since the unit was in operation, generator load could not be changed. All data were collected at full load.

If it were not for the vibration on bearing #9 this would be an excellent running turbine. All time and spectrum plots were dominated by running speed vibration. However, orbit plots and bearing centerline plots indicated alignment issues.

Orbit data from all bearings are not a true elliptical orbit. Bearing #1 (Figure 54) shows a very flat orbit. This orbit should be elliptical from the top right to the bottom left due to the counterclockwise rotation of the shaft. Centerline plots show the shafts sitting in the upper half of the bearings (Figure 55).

As for Bearing #9 the time plot is clipped in the y direction. The orbit is very flat and in line with the y proximity probe (Figure 56). Additionally, the centerline plot (Figure 57 and Table 5) indicates that this bearing has the shaft sitting higher in the bearing than anywhere else on the turbine.

The data on this bearing, clipping and centerline plot, coupled

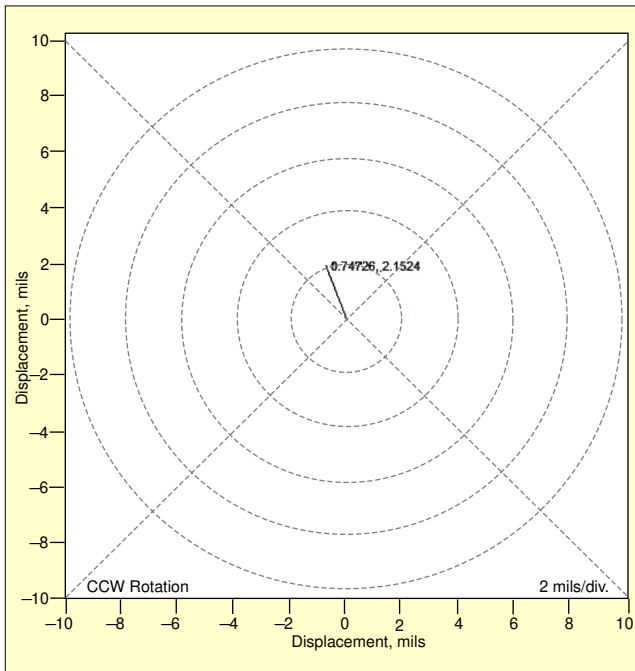

Figure 59. Bearing #10 shaft centerline.

Table 5. Proximity probe gap changes since Spring 2005.

Probe Location	Gap Change
1x.....	.8.40 mil rise
1y.....	1.85 mil drop
2x.....	.6.95 mil rise
2y.....	.3.45 mil rise
3x.....	.6.10 mil rise
3y.....	.2.10 mil rise
4x.....	.9.45 mil rise
4y.....	.5.95 mil rise
5x.....	.9.00 mil rise
5y.....	.3.30 mil rise
6x.....	.8.35 mil rise
6y.....	.0.90 mil rise
7x.....	.7.40 mil rise
7y.....	.3.10 mil rise
8x.....	.7.55 mil rise
8y.....	.1.80 mil rise
9x.....	.11.3 mil rise
9y.....	.2.10 mil rise
10x.....	.1.00 mil rise
10y.....	.2.05 mil rise
11x.....	.0.74 mil drop
11y.....	.4.65 mil drop

with the erratic behavior of the vibration phase and amplitude indicate two problems. The erratic behavior and the clipped wave are an indication of a rub. The rub is mostly the result of alignment issues on the shaft. The misalignment of the shaft causes clearance problems with the seals. When the clearances are insufficient, the seals rub.

Bearing #10 has the most conclusive indication of alignment issues. The orbit is a “figure 8” (Figure 58). The shaft centerline plot (Figure 59) shows that the shaft is sitting in the upper left quadrant of the bearing.

Results – This unit was exhibiting a fairly severe alignment issue that is causing seal rubbing. The unit, however, is needed for electrical loads and can’t be shutdown for repairs. Operation personnel have been told to reduce load if the vibration levels get above 7.5 mils_{pk-pk}.

Conclusions – During the Spring 2005 overhaul, the turbine contractor had problems with the alignment between the ‘B’ low pressure turbine and the generator. This problem appears to not have been corrected. Additionally, the plant installed a new type packing in the turbine that sits closer to the shaft than normal packing. The new style packing along with the alignment issues has caused the rubbing problems on bearing #9. 

The author can be reached at: krguy@delawareanalysis.com.