

## Overview

The Ceres board provides a ready-made development platform for Digilent C-Mod boards. It contains a 40-pin DIP socket to hold C-Mods, and a collection of useful I/O devices connected to the socket pins. The Ceres/C-Mod board combination makes an ideal platform for students or engineers who want to experiment with modern design technologies and/or Xilinx CPLD devices. The Ceres board can operate from a wall-plug power supply (included), or up to 40 hours on two AA batteries. Ceres features include:

- An user-settable oscillator (0.5Hz - 4KHz);
- 4-digit, high-bright seven-segment display;
- 4 debounced buttons and 8 slide switches;
- 8 LEDs in three different colors (red, green, and yellow);
- 40-pin Dip format receptacle for use with the C-Mod line of boards;
- 40-pin expansion connector capability.
- Attached C-Mod boards can be programmed with JTAG3 cable.

The Ceres/C-Mod board makes an excellent platform for introducing programmable technologies in instructional lab settings. The C-mod boards can host a wide range of designs, from simple logic circuits to complex state machines. The CPLDs use non-volatile configuration memory, so designs can be completed outside the lab and brought in for evaluation. The Ceres/C-mod combination is fully compatible with all versions of the Xilinx CAD tools, including the free WebPack tools available at the Xilinx website. When purchased in combination, the Ceres/C-Mod ships with a programming cable and a power source, so designs can be implemented immediately without the need for any additional hardware.

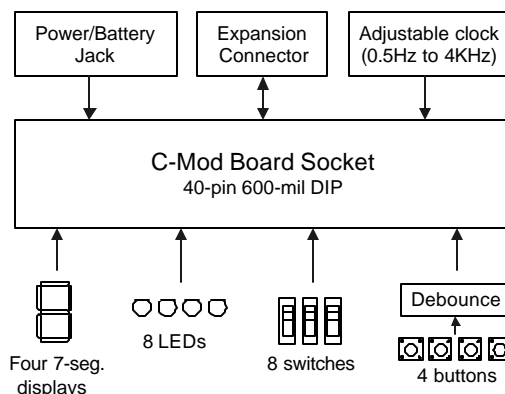

Figure 1. Ceres Block Diagram

## Functional description

The Ceres board provides a power supply and collections of I/O devices that can be used by C-Mod boards. Ceres boards can host different C-Mod boards, so designs can easily be retargeted to different CPLD devices for experimentation. Current C-Mod boards include the C-Mod 95 (XC9572XL), the C-Mod C2 (XC2C64), and the C-Mod XCR (XCR3064XL).

The Ceres board can be powered from a wall-plug power supply or from a 2AA battery pack. A 40-pin expansion connector makes all DIP connector signals available to external circuits.

## Ceres/C-Mod JTAG Configuration

C-Mod boards contain a JTAG port for programming, but the Ceres board does not. The C-Mod JTAG port consists of a pattern of six offset holes that are not normally loaded with header pins. A row of 6 unattached header pins can be inserted into the end of a JTAG3 cable, and the other side of the header can be inserted into the offset hole patterns.

Once the C-Mod board is connected to the PC via the JTAG cable, the configuration software will automatically detect the CPLD. For more information, see the “Configuration” section of the C-Mod reference manual.

## Oscillator

The Ceres board provides an user-adjustable oscillator that can produce a clock signal in the 0.5 to 4KHz range. The oscillator circuit uses an auto-feedback Schmidt-trigger inverter, with a variable resistor and fixed 4.7uF capacitor in the feedback path. The variable resistor is a 15-turn precision potentiometer that can be adjusted from 0 to 500K ohms, providing an RC time constant that varies by several orders of magnitude. This clock source provides an adequate frequency range for experiments that run from “human time” (i.e., less than 1 Hz) to the audio range. The oscillator output drives the CLK0 input of the CPLD via a second Schmidt trigger.

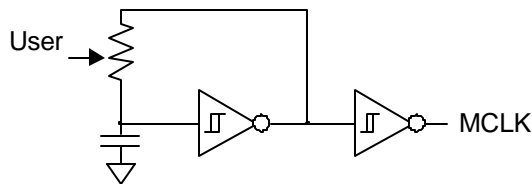

Figure 2. Ceres Oscillator

## Power Supplies

The CERES board can be powered from any wall-plug transformer that uses a 2.1mm center-positive jack, and that produces at least 100mA in the 5VDC to 9VDC range. The board can also be powered from a secondary power connector that bypasses the onboard regulator. This 2-pin header can accommodate a 2AA battery pack or any other power source that outputs at least 100mA at 2.5VDC to 4.0VDC (if a supply of more than 4VDC is applied to the secondary connector, the C-Mod will be permanently damaged). During operation, the board consumes less than 80mA with all LEDs and LED segments illuminated.

## Discrete LEDs

Eight individual LEDs are provided for circuit outputs. The LED cathodes are tied to Vdd via 240-ohm resistors, and the LED cathodes are driven directly from the C-Mod board.

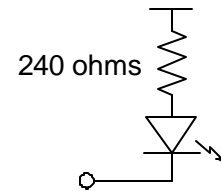

Figure 3. LED circuit

## Button Inputs

The Ceres contains four normally open pushbuttons. Button outputs are pulled to Vdd by a 47K resistor. When the button is pressed, the output is connected to GND via a 4.7K resistor. This results in a logic signal that is low ( $1/10^{\text{th}}$  of Vdd) only while the button is actively pressed, and high at all other times. The buttons are debounced with an RC filter and Schmidt-trigger inverter as shown in the figure below. This circuit creates a logic high signal when the button is pressed. The debounce circuit provides ESD protection and creates a signal with clean edges, so the BTN# signals can be used as clock signals if desired.

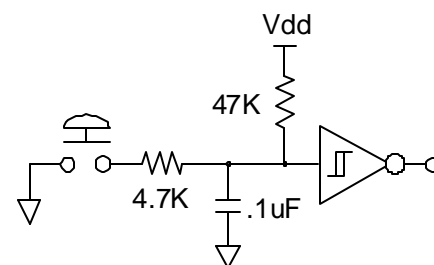

Figure 4. Pushbutton circuit

## Slide Switches

Eight slide switches are provided for circuit inputs. The slide switches use a 4.7Kohm series resistor for nominal input protection.

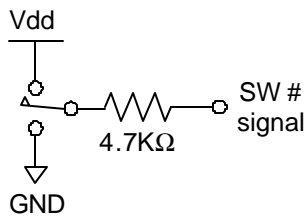
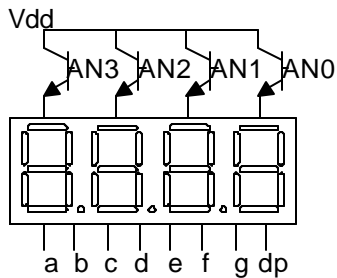

Figure 5. Slide Switches

### Seven Segment LED display

The Ceres board contains a 4-digit common anode seven-segment LED display. The display is multiplexed, which means only seven cathode signals exist to drive all 28 segments in the display. Four digit-enable signals drive the common anodes, and these signals determine which digit the cathode signals illuminate.

**Anodes** are connected via transistors for greater current



**Cathodes** are connected to Xilinx device via 100 Ω resistors

Figure 6. Common Anode Sseg display

The seven anodes of each digit's LEDs are connected together into one "common anode" circuit node. The display has four such nodes named AN0 – AN3, and the signals that drive these nodes serve as digit enables. Driving an anode signal low enables the corresponding digit. The cathodes of similar segments on all four displays are connected into seven circuit nodes labeled CA through CG. Driving cathode signals low illuminates segments on any digit whose digit enable is low.

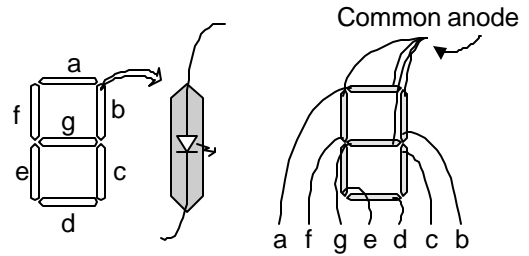

Figure 7. Common Anode Detail

This connection scheme creates a multiplexed display, where driving the anode signals and corresponding cathode patterns of each digit in a repeating, continuous succession can create the appearance of a 4-digit display. Each of the four digits will appear bright and continuously illuminated if the digit enable signals are driven low once every 1 to 16ms (for a refresh frequency of 1KHz to 60Hz). For example, in a 60Hz refresh scheme, each digit would be illuminated for 1/4 of the refresh cycle, or 4ms. The controller must assure that the correct cathode pattern is present when the corresponding anode signal is driven.

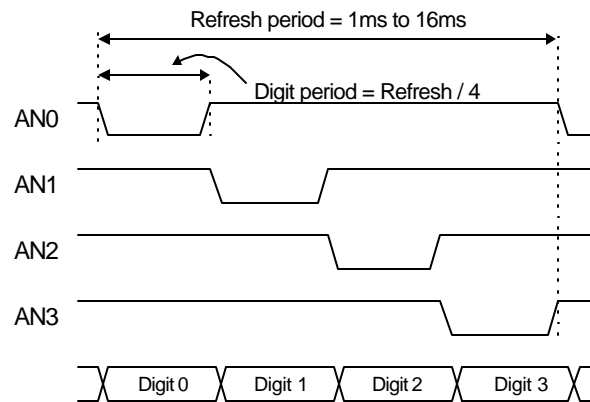

Figure 8. Sseg signal timing

To illustrate the process, if AN0 is driven low while CA and CB are driven low, then a "1" will be displayed in digit position 0. Then, if AN1 is driven low while CA, CB and CC are driven low, then a "7" will be displayed in digit position 1. If AN0 and CB, CC are driven low for 4 ms, and then AN1 and CA, CB, CC are driven low for 4 ms in an endless succession, the display will show "71" in the rightmost two digits.

Digit Shown	Cathode Signals						
	a	b	c	d	e	f	g
0	0	0	0	0	0	0	1
1	1	0	0	1	1	1	1
2	0	0	1	0	0	1	0
3	0	0	0	0	1	1	0
4	1	0	0	1	1	0	0
5	0	1	0	0	1	0	0
6	0	1	0	0	0	0	0
7	0	0	0	1	1	1	1
8	0	0	0	0	0	0	0
9	0	0	0	1	1	0	0

Figure 9. Sseg cathode signals for digits

### Expansion connector

An expansion connector labeled J1 is included on the edge of the Ceres board to allow designs to be expanded beyond the board. No connector is loaded during manufacturing to allow greater flexibility (so that wire-wrap pins can be loaded, or a male or female connector). All available CPLD signals are routed to the connector, including signals that drive on-board devices. Where feasible, on-board devices are decoupled from the CPLD with series resistors so that all pins may be used as inputs or outputs by the expansion connector. VCC and GND are also routed to the connector so that attached devices can draw power from the Ceres board. Table 1 shows the signals routed to the expansion connector.

Pin	Signal	Pin	Signal	Pin	Signal	Pin	Signal
1	GND	11	SW4	21	NC	31	LED4
2	VU	12	BTN2	22	AN1	32	CE
3	VCC	13	SW3	23	NC	33	LED3
4	NC	14	BTN1	24	AN2	34	CD
5	SW7	15	SW2	25	LED7	35	LED2
6	NC	16	BTN0	26	AN3	36	CC
7	SW6	17	SW1	27	LED6	37	LED1
8	NC	18	DP	28	CG	38	CB
9	SW5	19	SW0	29	LED5	39	LED0
10	BTN3	20	AN0	30	CF	40	CA

### 40 Pin DIP Socket

The Ceres Board is designed to accept any one of several C-Mod boards. C-Mods can easily be inserted into or removed from the 40 pin DIP socket. To add or change a C-Mod board, power off the Ceres (disconnect the power supply), remove an existing C-Mod board if needed, and press the new C-Mod into the DIP socket, ensuring that Pin 1 on the C-Mod is aligned with Pin 1 on the socket. Table 2 shows the signals routed to the 40-pin DIP socket.

Pin	Signal	Pin	Signal	Pin	Signal	Pin	Signal
1	CA	11	CG	21	GND	31	LED6
2	CB	12	AN3	22	SW6	32	LED5
3	CC	13	AN2	23	SW5	33	BTN0
4	CD	14	AN1	24	SW4	34	BTN1
5	NC	15	AN0	25	SW3	35	MCLK
6	NC	16	SW7	26	SW2	36	LED4
7	NC	17	DP	27	SW1	37	LED3
8	NC	18	BTN3	28	BTN2	38	LED2
9	CE	19	NC	29	SW0	39	LED1
10	CF	20	VCC	30	LED7	40	LED0